

Rowan University

Rowan Digital Works

---

Theses and Dissertations

---

10-3-2019

## Mobile ad hoc networks in transportation data collection and dissemination

Kardigue Konte  
*Rowan University*

Follow this and additional works at: <https://rdw.rowan.edu/etd>

 Part of the [Digital Communications and Networking Commons](#), and the [Electrical and Computer Engineering Commons](#)

---

### Recommended Citation

Konte, Kardigue, "Mobile ad hoc networks in transportation data collection and dissemination" (2019).  
*Theses and Dissertations*. 2742.  
<https://rdw.rowan.edu/etd/2742>

This Thesis is brought to you for free and open access by Rowan Digital Works. It has been accepted for inclusion in Theses and Dissertations by an authorized administrator of Rowan Digital Works. For more information, please contact [graduateresearch@rowan.edu](mailto:graduateresearch@rowan.edu).

**MOBILE AD HOC NETWORKS IN TRANSPORTATION DATA COLLECTION  
AND DISSEMINATION**

by

Kardigue Konte

A Thesis

Submitted to the  
Department of Electrical and Computer Engineering  
College of Engineering  
In partial fulfillment of the requirement  
For the degree of  
Master of Science in Electrical and Computer Engineering  
at  
Rowan University  
January 25, 2019

Thesis Chair: John L. Schmalzel, Ph.D., P.E.

© 2019 Kardigue Konte

## **Dedications**

My thesis is dedicated to my beloved Family and Advisor Dr. Schmalzel, John L.

## Acknowledgments

I would like to express my deepest gratitude to my advisor Dr. Schmalzel L John and my associate advisor Dr. Parth Bhavsar, and Dr. Kazemi Farzan for teaching me and believing in my abilities. This research would not be achieved without their invaluable guidance, understanding, patience, and support. My sincere gratitude to Dr. Sangho Shin for his amazing support and good advice.

I thank all the Electrical and Computer Engineering and Civil Engineering Faculty members. Without their patience and help throughout the last two years, this research would not have been a success. My deepest gratitude to my family, professors, and my friend Amadou Kane for their fantastic support. My sincere thanks to my brothers Cheick Oumar Tidiani Konte, Kissima Konte, and Souleymane Diarra.

## Abstract

Kardigue Konte  
MOBILE AD HOC NETWORKS IN TRANSPORTATION DATA COLLECTION  
AND DISSEMINATION  
2016-2019  
John L. Schmalzel, Ph.D., P.E.  
Master of Science in Electrical and Computer Engineering

The field of transportation is rapidly changing with new opportunities for systems solutions and emerging technologies. The global economic impact of congestion and accidents are significant. Improved means are needed to solve them. Combined with the increasing numbers of vehicles on the road, the net economic impact is measured in the many billions of dollars. Promising methodologies explored in this thesis include the use of the Internet of Things (IoT) and Mobile Ad Hoc Networks (MANET). Interconnecting vehicles using Dedicated Short Range Communication technology (DSRC) brings many benefits. Integrating DSRC into roadway vehicles offers the promise of reducing the problems of congestion and accidents; however, it comes with risks such as loss of connectivity due to power outages as well as controlling and managing loading in such networks. Energy consumption of vehicle communication equipment is a crucial factor in high availability sensor networks. Sending critical emergency messages through linked vehicles requires that there always be energy and communication reserves. Two algorithms are described. The first controls energy consumption to guarantee an energy reserve for sending alert signals. The second exploits Long Term Evolution (LTE) to guarantee a reliable communication path.

## Table of Contents

Abstract .....	v
List of Figures .....	vii
List of Tables .....	viii
Chapter 1: Introduction .....	1
1.1 Motivation.....	2
1.2 Problem Statement .....	3
1.3 Contribution .....	4
1.4 Thesis Outline .....	4
1.5 Summary.....	5
Chapter 2: Related Work .....	6
2.1 Mobile Ad Hoc Network (MANET) .....	6
2.2 Reliability of Wireless Network.....	6
2.3 Cellular Communication .....	7
2.4 Mobile Ad Hoc Network Concepts .....	8
2.5 Characteristics of Mobile Ad Hoc Networks .....	9
2.5.1 Dynamic Network Topology. ....	9
2.5.2 Autonomous Nodes and Self-Organization. ....	9
2.5.3 Hidden Nodes.....	10
2.6 Routing in Mobile Ad Hoc Network .....	10
2.6.1 Proactive Protocols .....	11
2.6.2 Reactive Protocols .....	13
2.6.3 Hybrid Protocols .....	13

## Table of Contents (Continued)

2.7 Comparison of Ad Hoc Routing Protocols.....	14
2.8 Routing Problems .....	15
2.9 MANET Applications .....	15
2.10 MANET Concepts .....	15
2.11 Hybrid Communication.....	16
2.12 Dedicated Short-Range Communication.....	17
2.12.1 Spectrum .....	17
2.12.2 Extension of IEEE 802.11x to .11p .....	19
2.12.3 Different Types of DSRC .....	20
2.12.4 Communication Processes .....	20
2.12.5 Wired Communication.....	21
2.12.6 Wireless Communication.....	22
2.12.7 Bandwidth and Data Transmission.....	22
2.12.8 Vehicle-to-Vehicle Communication.....	23
2.12.9 Vehicle-to-Infrastructure Communication.....	23
2.12.10 DSRC Applications.....	27
2.12.11 DSRC Deployment Concerns .....	28
2.12.12 Mobile Data Collection and Dissemination Platform.....	34
2.12.13 Communication Interface and Vehicle Subsystems .....	35
2.13 Wireless Sensor Network Applications.....	35
2.14 Summary .....	36
Chapter 3: Energy Consumption and Congestion Control Algorithms .....	37



## Table of Contents (Continued)

3.1 Energy Consumption Issues in Wireless Networks .....	37
3.2 DSRC Channel Congestion.....	39
3.2.1 Channel Congestion Control Problems .....	39
3.2.2 Previews of Congestion Control Techniques .....	40
3.2.3 Study Research Questions .....	41
3.3 Long Term Evolution (LTE) Technology.....	42
3.4 Routing Strategy and Dijkstra Algorithm .....	43
3.5 Summary .....	44
Chapter 4: Methods.....	45
4.1 Introduction.....	45
4.2 Energy Consumption Optimization Algorithm.....	46
4.2.1 Energy Consumption in Vehicular Networks .....	47
4.2.2 Implementing Dijkstra’s Algorithm .....	48
4.2.3 Algorithm Energy Consumption Control.....	49
4.3 Energy Consumption Experimental Setup.....	50
4.3.1 Power Source.....	51
4.3.2 Raspberry Pi 3 B+ and DS18B20 Temperature Sensor .....	51
4.3.3 INA219 Bidirectional Current-Power Monitor and I2C Communication .....	52
4.3.4 Sensor Energy Consumption .....	53
4.3.5 Test Process for Energy Consumption .....	54
4.3.6 Remaining Energy .....	55
4.3.7 Integrated Systems Health Management.....	55
4.4 Congestion Control.....	56

## Table of Contents (Continued)

4.4.1 DSRC Networks Congestion Control.....	57
4.4.2 Algorithm DSRC Networks Congestion Control.....	58
4.4.3 Evaluation of DSRC Network Congestion.....	58
4.4.4 Possible Solution to Network Congestion.....	65
Chapter 5: Results and Discussion.....	67
5.1 Instantaneous Energy Consumption.....	67
5.2 DSRC Network Congestion Analysis .....	70
5.3 DSRC Network Congestion Control .....	72
5.4 DSRC Channel Performance with Different Traffic Scenarios .....	75
Chapter 6: Conclusions and Recommendations .....	77
6.1 Remarks.....	77
6.2 Future Work .....	77
References.....	79

## List of Figures

Figure	Page
Figure 2.1 Cellular networks.....	8
Figure 2.2 Dynamic topology of mobile ad hoc networks.....	9
Figure 2.3 Hidden nodes and routing protocols.....	10
Figure 2.4 Different routing protocols for mobile ad hoc networks .....	11
Figure 2.5 Vehicular and computer networks.....	16
Figure 2.6 Channel management and frequency spectrum.....	18
Figure 2.7 General model of communication system .....	21
Figure 2.8 DSRC V2V and V2I communication .....	23
Figure 2.9 V2V and V2I environment .....	24
Figure 2.10 DSRC communication infrastructure .....	25
Figure 2.11 Scalability of basic safety messages.....	28
Figure 2.12 Compares the protocol stack of IEEE 802.11/p-WAVE to the generic OSI 7-layer model.....	32
Figure 2.13 DSRC protocol stack .....	33
Figure 2.14: Mobile data collection and dissemination platform .....	34
Figure 2.15 Vehicle Communication Subsystems .....	35
Figure 3.1 LTE Long Range Communication .....	42
Figure 3.2 Optimal Path using Dijkstra's Algorithm.....	44
Figure 4.1 Methods to evaluate energy consumption and network congestion.....	46
Figure 4.2 Flowchart of energy consumption .....	47
Figure 4.3 Vehicular energy communication and links energy .....	48

### List of Figures (Continued)

Figure 4.4 Algorithm for Energy Consumption Optimization.....	50
Figure 4.5 Experimental Setup .....	51
Figure 4.6 Flowchart of Congestion Control .....	57
Figure 4.7 Congestion control algorithm .....	58
Figure 4.8 Relationship between Flow and Density .....	61
Figure 4.9 Traffic Congestion State and Congestion Control State.....	63
Figure 4.10 Traffic congestion as a function of speed.....	64
Figure 4.11 The use of LTE communication as a control channel .....	66
Figure 5.1 Instantaneous (every 30s) energy consumption plotted against sensor power consumption.....	68
Figure 5.2 Starting energy and instantaneous remaining energy .....	68
Figure 5.3 Connecting vehicles from origin V24 to destination V66.....	69
Figure 5.4 List of vehicles that v24 can connect to with different costs .....	70
Figure 5.5 Channel Congestion when Density is more than 187 vehicles (45 mph).....	71
Figure 5.6 DSRC Channel with and without Congestion at Speed 70 mph .....	73
Figure 5.7 DSRC Channel with and without Congestion at Speed 65 mph .....	73
Figure 5.8 DSRC Channel with and without Congestion at Speed 45 mph .....	74
Figure 5.9 DSRC Channel with and without Congestion at Speed 25 mph .....	74
Figure 5.10 DSRC Channel with and without Congestion at Speed 5 mph .....	75
Figure 5.11 Basic Safety Messages of Vehicles at Different Speeds .....	76

## List of Tables

Table	Page
Table 2.1 Comparison of protocols.....	14
Table 2.2 DSRC application mobility and environment.....	28
Table 3.1 Data rate supported at 10 MHz.....	39
Table 4.1 Components used in experimental setup .....	53

## Chapter 1

### Introduction

This chapter briefly discusses the motivation for addressing the challenges of vehicle-to-vehicle communication and why solutions to a variety of problems faced in today's vehicular communication are needed. Intelligent Transportation Systems have emerged as a means to reduce congestion and to make roads safer and more reliable. However, with increasing numbers of vehicles and accidents, road transport consumes significant amounts of driving time. To address these challenges, Vehicle-to-Vehicle and Vehicle-to-Infrastructure communication are active areas of research to define the innovative services needed to make driving smarter, coordinated, connected and safer. This thesis proposes two efficient and practical approaches to overcome some of the substantial challenges in intelligent transportation systems.

#### 1.1 Motivation

It is well established that increasing traffic congestion is one of the significant issues facing the transportation sector and automobile safety is a worldwide problem. Despite the continuous improvements in vehicle safety, the associated problems are increasing due to continued growth in traffic volume. According to World Health Organization global status report on road safety, the worldwide total of traffic deaths is 1.35 million per year. Another 20-50 million are estimated to have suffered non-fatal injuries, with many of those incurring permanent disabilities [1, 2]. In addition to the safety ramifications resulting from improvements in transportation systems, improvements in transportation efficiencies could save billions of dollars, minimize

environmental impacts through reductions in carbon monoxide (CO), wasted fuel, and production of oxides of nitrogen (NO<sub>x</sub>), which are key contributors to air pollution and reduced air quality.

Engineers develop and provide many different solutions to ensure safety, and reduce human loss on highways. The Internet of Things (IoT) is an important emerging technology, which has been broadly applied in all domains such as transportation, space, healthcare, housing, and business. According to the US Department of Transportation (USDOT), intelligent traffic system (ITS) technologies improve transportation safety and mobility, reduce environmental impacts, and enhance the productivity through the integration of advanced communication-based information and electronic technologies into the transportation infrastructure and vehicles [3]. The development of ITS provides functions that can help prevent accidents for vehicles and pedestrians as well as provide strategies to reduce travel time. A communication framework includes vehicles-to-infrastructure (V2I), vehicle-to-vehicle (V2V), vehicle-to-nomadic devices (V2N), and infrastructure-to-vehicle network (IVN) to provide convenient services such as collision prevention, crash notifications, alerts to congestion areas, and traffic information collection through mobile terminals. A vehicular ad-hoc network (VANET) is a type of mobile ad-hoc network (MANET), which can be used to reduce network failures due to high vehicle mobility and provide information services to drivers [4]. Such networks support a wide range of communication protocols, in particular using IEEE 802.11p wireless technology. Despite the performance and large bandwidth of IEEE 802.11p, traffic congestion and network congestion remain problematic. This has spurred continued vehicle-to-everything (V2E) innovation. This thesis employs a MANET

system for communication between vehicles and with fixed infrastructure to collect data, maintain vehicle communications, determine power source status and provide methods to reduce vehicle network congestion.

## **1.2 Problem Statement**

One drawback of MANET is the challenge of maintaining reliable communication links between high mobility nodes. With the increase of numbers of vehicles in service, collecting and transmitting traffic data in real time has become a critical challenge. Data not collected, processed, and analyzed appropriately causes negative impacts on traffic and safety operations. Frequent questions addressing the data collection problems include: “Where and how such information delays can happen?” and “How to manage big data gathered from roadways to avoid congestion?” The proliferation of vehicles with intelligent onboard systems will provide large amounts of data, which in turn will create new problems of correlation and mapping. One specific example is the need to correlate a vehicle’s position (GPS) with data generated by that same vehicle—for example, a photograph of a roadway mapping between the global position system (GPS) data and corresponding images. Sensors play an important role and are an important addition to large-scale data acquisition networks due to the large number of issues they successfully address [5]. Vehicles will be equipped with a set of intelligent sensors, which are likely to require more bandwidth due to higher sampling rates. Insufficient bandwidth of available communication channels may cause network congestion, as well as channel and compatibility problems between active and passives sensors, roadside units, and data routers. These issues are directly related to data collection design and communication architecture, which must support reliable data management, minimize network



congestion, account for total energy consumption, and maintain low latency. Dedicated short range communication (DSRC) technology promises to improve roadway connectivity and data connection in real-time. Limited storage and insufficient communication channels are the most substantial drawbacks associated with signals reaching their intended destinations.

The problems addressed in this thesis research include: (1) energy awareness to maximize the probability for sending safety critical messages, (2) approaches to minimize traffic congestion and network congestion.

### **1.3 Contribution**

Among the multiple challenges of IoT technology; energy consumption and dedicated short range communication (DSRC) channel congestion are the main focuses of this research. To maintain interoperability and exchange of data in real time, this thesis proposes two algorithms: The first algorithm is designed to monitor energy consumption in vehicles equipped with DSRC; the second algorithm reduces DSRC network congestion by exploiting available cellular Long Term Evolution (LTE) networks.

### **1.4 Thesis Outline**

Chapter I introduces the motivation for this work and discusses related problems. Chapter II reviews related work dealing with mobile ad hoc network implementation and its benefit in the vehicle domain including discussion of DSRC. Chapter III describes energy consumption and congestion control algorithms. Chapter IV covers the experimental methods used for energy consumption and network congestion. Chapter V

presents results from this investigation. Conclusions and recommendations for future work are presented in Chapter VI.

## **1.5 Summary**

This thesis focuses on innovative methods to utilize wireless and wired communication methods for traffic data collection and dissemination. The project utilizes a mobile data collection platform (described in Chapter IV), which can have multiple sensors modules communicating with a microcontroller hub. Vehicles were equipped with a DSRC unit and other sensors connected to a power source with a cognitive awareness system developed to decide whether or not to transmit data when energy is low. One benefit of power control is maintenance of an energy reserve to allow sending an emergency signal if the vehicle primary power source is lost during an accident. The backup power source reserve is sufficient to locate the vehicle after the accident using the multi-point routing system.

## Chapter 2

### Related Work

Advance next-generation communication technologies offer the potential to greatly improve safety, system efficiency, and mobility on the roads [6]. Fundamental to mobile communication are MANET and DSRC technologies.

#### 2.1 Mobile Ad Hoc Network (MANET)

Wireless technology is a common system of communication used to distribute data especially between high mobility nodes such as automobiles. Nodes communicate using a variety of licensed bands between 600MHz and 5.2GHz. The mobile environment can be classified into (1) mobile networks with infrastructure and (2) mobile networks without infrastructure. Infrastructure base stations maintain wireless communication with mobile devices in cells of a specific range and are in turn connected to each other by terrestrial interconnect (copper or fiber), which provide reliable high bit rate communication.

In contrast to fixed base stations, the fluid nature of mobile nodes makes it necessary to form—and continuously reform—ad hoc connections to provide the means to network the mobile nodes.

#### 2.2 Reliability of Wireless Network

Wireless communication is less reliable than wired communication due to the variable path environment that variously attenuates and/or reinforces the signal over different propagation segments. Weather, path length, the urban environment, and

vegetation in rural areas are common variables determining the resulting attenuation, fade, and ghosting that determine final signal quality. These problems effectively limit the effectiveness of mobile communication. One method that can reduce the impact of the variable mobile pathways is to use stationary nodes to forward packets from one node to another to improve the overall connection reliability of a mobile ad hoc network.

### **2.3 Cellular Communication**

Cellular wireless communication networks also use similar classes of nodes: Mobile nodes are typically handheld devices, which connect to base stations (towers). In turn, base stations are interconnected with copper or fiber optics. The standard configuration of the cellular communication system is a mesh of hexagonal cells. If there is a large volume of mobile users in a cell footprint, the main cell can be further divided into multiple small cells to form micro cells. As mobile nodes move, their network links are broken and reformed using handoff protocols. In vehicular communication, the rapid dynamic changes in location of devices is the dominant issue affecting network reliability. A useful synergy is to exploit available cellular communication infrastructure as shown in figure 2.1, based on protocols such as long term evolution (LTE), which is a global cellular standard supporting broadband internet access [7].

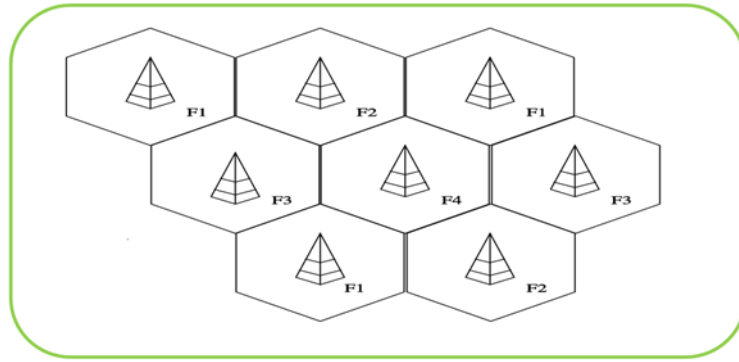

*Figure 2.1.* Cellular networks

## 2.4 Mobile Ad Hoc Network Concepts

The main difference between a MANET and a conventional network is the lack of fixed support from base stations. Since such networks are easily created, they are the obvious means to support vehicular communication. The absence of a base station requirement means that ad hoc networks can be deployed quickly without any device planning or construction of expensive network infrastructure. As shown in figure 2.2, all nodes are moving at different speeds and directions. This free mobility results in highly variable links. Nearby nodes exchange information without needing additional routing; however, larger node-node separation requires routing protocols to provide connectivity.

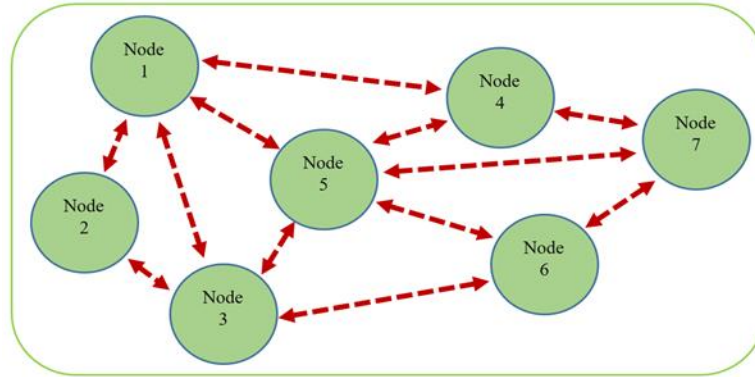

*Figure 2.2. Dynamic topology of mobile ad hoc networks*

## 2.5 Characteristics of Mobile Ad Hoc Networks

**2.5.1 Dynamic network topology.** Dynamic network topology is the key element characterizing a MANET. This topology is a critical part of mobile ad hoc networks because all nodes are free to move arbitrarily. Connectivity among vehicles will vary with time with attendant loss of data. Implementing MANET into a vehicular network must address the high mobility issue, adapt to the traffic and propagation conditions as well as to the patterns of the mobile nodes.

**2.5.2 Autonomous nodes and self-organization.** In MANETs, each mobile terminal functions as an autonomous node supporting both host and router capabilities. In addition to onboard vehicle nodes, cable-connected roadside units are also key network elements. To communicate, fixed and mobile nodes must dynamically discover other nodes to complete a path. Addressing and position location are important to establish reliable data through Wi-Fi. The power consumption of each node needs to be optimized to avoid unnecessary reconfigurations due to drop out secondary to power loss. For battery operated nodes, the imposed energy constraint is a key design criterion.

**2.5.3 Hidden nodes.** Hidden nodes are often present in wireless environments. An example is shown in figure 2.3. In the left side of the figure, node 1 and node 2 cannot exchange information because an obstacle interrupts wave propagation. The use of another node as shown in the right side makes communication possible between these two hidden nodes. In a vehicular network, hidden nodes can result when two vehicles enter an obscured intersection or ramp. In such cases, a roadside unit can be the third element, which makes ad hoc communication possible.

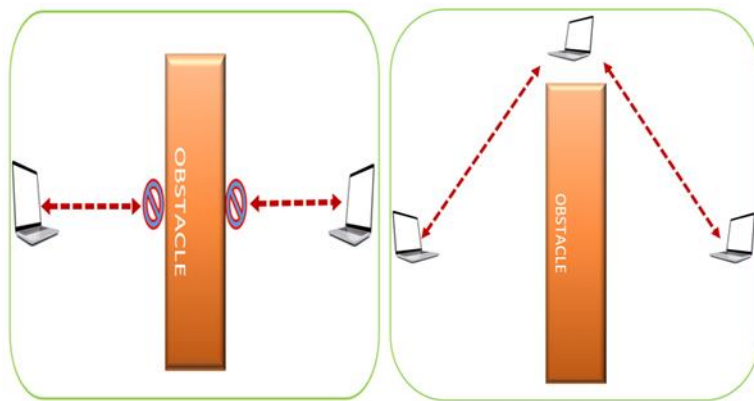

*Figure 2.3. Hidden nodes and routing protocols*

## **2.6 Routing in Mobile Ad Hoc Network**

Routing is defined as a strategy that allows data to reach a final destination by using a path consisting of intermediate nodes. MANET is a collection of nodes, which need to exchange information in order to perform communication. The wireless radios routed in MANET are usually implemented through multi-hop, due to the short communication ranges inherent in low power transmitters; routing is performed by intermediate mobile nodes [8]. To forward data to its destination, a route can be either

directed or non-directed. In a direct route, nodes are close enough to be within signal range, which doesn't require routing protocols to reach their destination. This is also known as single hopping. When intermediary nodes are required to reach a destination, multi-hopping is needed. General classes of ad hoc network routing protocols include proactive, reactive, and hybrid proactive/reactive as shown in figure 2.4.

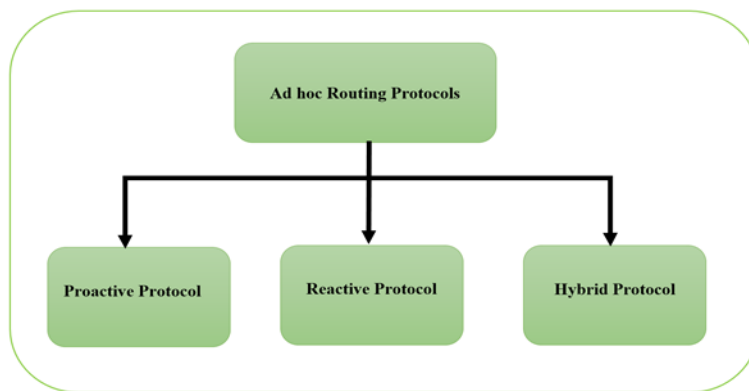

Figure 2.4: Different routing protocols for mobile ad hoc networks

**2.6.1 Proactive protocols.** The core principle for proactive protocols is the maintenance of tables that capture pathways constructed through sequences of requests. Proactive protocols are typically based on two main methods including Link State, and Distance Vector. This routing technique is similar to the techniques used in wired networks. Using Long Term Evolution (LTE) infrastructure, a central node can broadcast a request message to all nodes within range. The principal drawback of this algorithm is the excessive route maintenance required.



**2.6.1.1 Link state method LSM.** The Link State algorithm requires each node to periodically interrogate the status of links with its neighbors and update the network topology. Nodes calculate routes for reaching a destination, which supports route discovery when interruptions break the current path. A function termed flooding, provides multiple alternative pathways from the source node to nearest neighbors, which in turn rebroadcast the message until the message reaches its destination. The drawback of flooding is the potential for network loading with attendant increases in the error rate.

**2.6.1.2 Distance vector method (DVM).** In contrast to LSM, the Distance Vector approach estimates distance between a source node, neighbor nodes, and its destination node. Messages received from neighboring nodes are used to calculate shortest pathways to a destination. This is possible because the link costs are known between neighboring nodes. This process is repeated when the distance between nodes changes, which is characteristic of MANETs. One advantage of DVM is the avoidance of network flooding because the initiator informs its neighbors when a topology change is detected. However, DVM is inefficient when links are broken. Alternative modifications include the Destination Sequenced Distance Vector DSDV method.

**2.6.1.3 Optimized link state routing protocol (OLSR).** The Optimized Link State Routing (OLSR) protocol improves performance through the methods used to identify initiator neighbors needed for multipoint communication by balancing repetitive queries while maintaining sufficient network discovery. The OLSR protocol borrows features found in the link state algorithm [9], to enhance stability. OLSR mitigates some of the problems associated with flooding in LSM using only special multipoint nodes to transport messages. This provides shortest network paths through the use of

unidirectional and bidirectional links with each node asserting their direct links with adjacent nodes serving as routers and maintaining route tables to support route discovery. In the OLSR protocol, nodes exchange information periodically in order to maintain updated routing tables.

**2.6.2 Reactive protocols.** This class of protocols are also termed On-Demand Routing Protocols. Their approach does not assume predefined routes, instead only developing routes as needed by reacting to requests. This substantially reduces the chance of flooding. To exchange data with a neighbor, a node first sends an acknowledge message to identify possible routing information. Further subtypes of reactive protocols are available; for example, the widely used Ad Hoc On-demand Distance Vector AODV method. A drawback of reactive routing is the delay resulting from the overhead associated with link discovery.

**2.6.2.1 AODV routing.** The AODV protocol is a variant of the DSDV protocol incorporating reactive concepts. As mentioned above, DSDV is a proactive protocol in which nodes maintain routing tables of surrounding nodes and possible routes. This time- and memory-intensive process is reduced by AODV. If a node with data to send lacks route information, it broadcasts a route request in the form of a message route request. Received route response (RRS) messages are used to create a temporary routing table, which will be available as long as the route is in use. For cases of link failure detection, nodes notify others using a route error message (REM).

**2.6.3 Hybrid protocols.** Hybrid protocols combine reactive and proactive techniques to take advantages of the strengths of each to achieve higher levels of

efficiency and reliability. A hybrid approach employs a hierarchical arrangement based on surrounding nodes or groupings within network partitions. The mechanisms for combining multiple protocols increases complexity, but the benefits include more reliable networks.

## 2.7 Comparison of Ad Hoc Routing Protocols

Table 2.1 summarizes advantages and disadvantages of different protocols. It can be seen that proactive protocols have drawbacks of network saturation but benefit from low latency. In contrast, reactive protocols are less efficient because they have longer response time due to the overhead incurred by path search in addition to the time required to send data packets.

Table 2.1

### *Comparison of Protocols*

<b>Type of Protocol</b>	<b>Advantages</b>	<b>Drawbacks</b>
Proactive	Data or information always available	Flooding
Reactive	Path search only if needed	High latency due to request and response
Hybrid	Combines benefits from proactive and reactive protocols	Complexity and maintenance

## **2.8 Routing Problems**

Proactive protocols always have available routes, which offers the benefit of low latency when service is demanded. Updated route tables are maintained so as to be ready when data has to be sent [10]. As noted, one of the principal drawbacks is the potential for network flooding. However, another issue important in wireless sensor network (WSN) management is the high probability of limited energy. Thus, energy conservation is an important factor in all types of WSNs to prolong node life and thereby contribute to overall functionality of an entire network [11].

## **2.9 MANET Applications**

MANET concepts are found in diverse applications including, environmental, road safety, business, and natural disaster rescue operations. With advances in vehicular technology, MANET applied to traffic management is a natural extension. The principal technology foundation for MANET is DSRC, which is explained in this section to cover DSRC technology concepts, channel congestion, and energy consumption.

## **2.10 MANET Concepts**

MANET methods were developed to address routing problems encountered in computer networks with widely dispersed and mobile nodes. A MANET is a movable wireless network based on direct or multi-hopping communication to support thousands of devices at different ranges and speeds. MANET in the mobile vehicle environment is the dynamic changes of topology due to high vehicular mobility, which resulted in the failure of many networks to adequately support reliable communication between

vehicles. V2V infrastructure assumes the presence of high bandwidth, low latency networks [12]. Adapting MANET to support widely differing requirements is a challenge. For example, rural areas are characterized by long travel times compared to urban settings where traffic is often congested, which generates excessive greenhouse gases. Advances in MANET are needed for successful implementation into vehicular networks to create reliable communication systems serving roadside units, vehicles, and personal devices. The core fabric for wireless communications employ existing standards such as Wi-Fi and wired communication connecting infrastructure to central nodes. The composite extension of MANET to accommodate transportation systems is VANET, which is the vehicular ad hoc network equivalent.

## 2.11 Hybrid Communication

VANET can be considered an adaption of MANET principles to create a wireless network for data exchange to transform vehicles into network nodes as suggested by Fig. 2.5. Issues of stability, reliability, privacy, security, and scalability are important considerations.

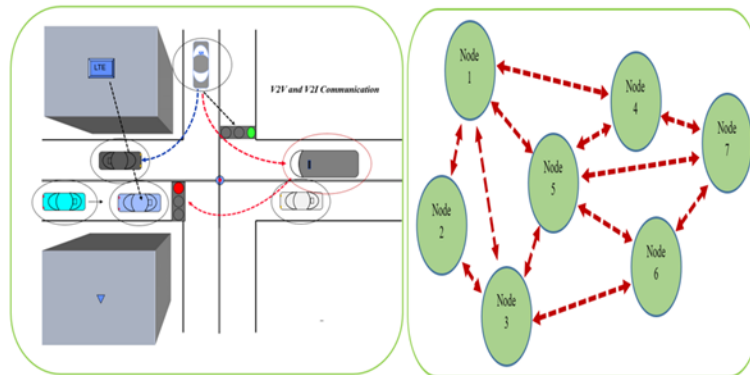

Figure 2.5. Vehicular and computer networks

In mobile ad hoc networks, mobile devices are nodes; in vehicular ad-hoc networks, vehicles are considered to be nodes. Development of effective VANET technologies can provide the foundation of intelligent transportation systems that improve road safety, time-critical safety operations, enhance traffic flows, reduce delays, among many others. Roadside units (RSUs) will be connected to supporting backbone infrastructure networks, which may be wired or wireless. Equivalent on-board units (OBUs) communicate with RSUs and other OBUs using cellular communication (GSM, LTE, 5G, etc.) to deliver both vehicle-to-vehicle (V2V) and vehicle-to-infrastructure (V2I) communication. Vehicles can communicate using a single hop or multiple hops, depending on the range of communication and node density and availability. The result is effective connection to the Internet or to distant vehicles [13]. The next section discusses VANET using DSRC communication technology and explains the concept of DSRC communication to explain DSRC and why it is the technology of choice.

## **2.12 Dedicated Short-Range Communication**

**2.12.1 Spectrum.** The availability of widely adopted, mature standards such as the IEEE 802.x family, J2735, etc., suggested that the broad challenge of connecting stationary and mobile nodes together to create effective smart transportation systems would be just another application extension. Early successes were achieved with electronic toll collection operating at 902-928 MHz using DSRC communication technology with a transmission rate of 0.5 Mb/s [14]. The US Federal Communication Commission (FCC) allocated 75 MHz of spectrum between 5.850-5.925 GHz [15] to be used for vehicles to everything (V2X) communication. The FCC regulates all communication by radio, wire, and satellite to provide access and avoid interference.

Dedicated Short Range Communication is a wireless spectrum allocation by the FCC in 1999 [16]. Initially, DSRC was focused on Vehicle-to-Infrastructure and Infrastructure-to-Vehicle. Smart transportation is an international endeavor with Europe and Japan also focused on applying technology to achieve safety, efficiency, and environmental benefits. Europe and Japan have allocated the spectrum of 5.8-5.9 GHz [17], which provides sufficient overlap to effectively create an international ITS communication infrastructure that can support common transmitter and receiver equipment. The wireless spectrum for vehicles is divided into seven (7), 10-MHz channels including one (1) control channel and six (6) service channels. There is a 5 MHz guard band to protect adjacent spectra. The control channel, also termed the detection channel, is responsible for maintaining and establishing communication links. 5.855-5.65 GHz (Channel 172) has been reserved for accident avoidance and life critical applications. Channel 184 is used for public safety; the remaining channels are designed for other types of smart highway applications. Channel allocations are depicted in Fig. 2.6.

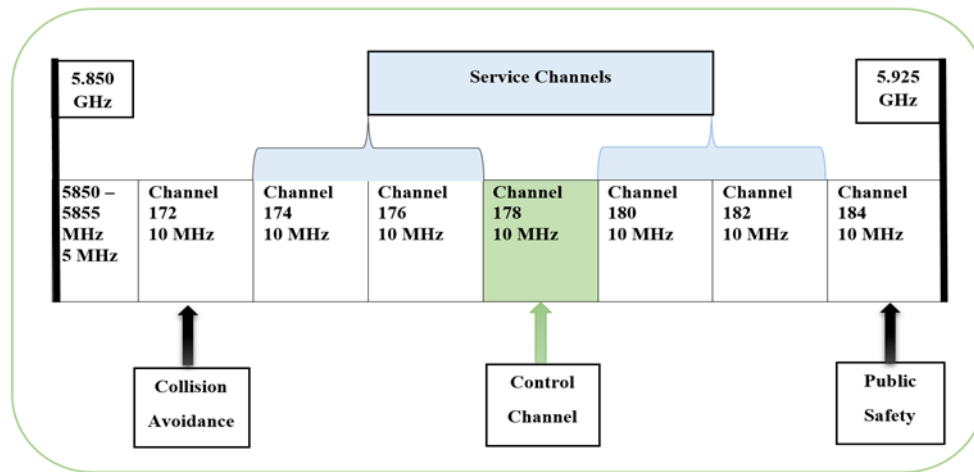

Figure 2.6. Channel management and frequency spectrum

**2.12.2 Extension of IEEE 802.11x to .11p.** A key performance requirement of DSRC technology is the need to provide very high, low latency data transfers. The Institute of Electrical and Electronics Engineers (IEEE) LAN/MAN Standards Committee (LMSC) has the responsibility of maintaining and extending the family of IEEE 802.x standards. A recent extension of the core IEEE 802.11a Wi-Fi standard was specifically developed to address the unique requirements of mobile environments where links need to be quickly established. IEEE 802.11p provides the changes needed to establish links without authentication. The trade-off for security is that those functions are pushed to other protocols. IEEE 802.11p focuses on the physical (PHY) and medium access control (MAC) layers to support low latency high dynamic mobility network topology. Maintaining the PHY and MAC layers within the IEEE 802.x family ensures compatibility over time [18].

**2.12.2.1 Low latency and high reliability.** Safety applications must recognize each other and transmit messages to each other in milliseconds with minimum delays. It is critical that there is interoperability between devices to allow successful deployment of active safety applications including collision avoidance, automatic braking systems, and transmission of emergency alerts to pedestrians, among many others. The principal difference between conventional Wi-Fi and DSRC technology is the latter's compatibility with high mobility to maintain network connectivity. DSRC not only works in high mobility conditions and in the presence of dynamic network topology change, but it also performs well under conditions of channel fading caused by precipitation.

**2.12.2.2 Security and privacy.** DSRC provides both safety message authentication and maintains privacy. Issues of privacy are of growing importance; users are generally



reluctant to have devices actively track their every move. DSRC must provide background changes of security certificates, MAC addresses, and other security attributes. One candidate for providing a security protocol is defined by IEEE 1609.x. This standard defines conditions for safety messages and how they should be processed as determined by the nature of the exchange [19]. One example are alert zone emergency signals, which can be sent to drivers in real-time to reduce the probability of accident.

**2.12.3 Different types of DSRC.** In active DSRC, information can be sent to a vehicle computer to control braking, acceleration, and other vehicle subsystems for automatic collision avoidance. For passive DSRC systems, feedback from a suite of sensors communicate road and vehicle status through an interface to the driver. Similar to the reduction in traffic fatalities that resulted from universal adoption of vehicle seat belts, the combination of active and passive DSRC technologies are expected to play a crucial role in further accident reduction.

**2.12.4 Communication processes.** Communication is the process of exchanging information between devices [20]. A basic model of a communication system is shown in Fig. 2.7. A transmitter sends data over a channel, which may be corrupted by noise, to a receiver where the data is decoded.

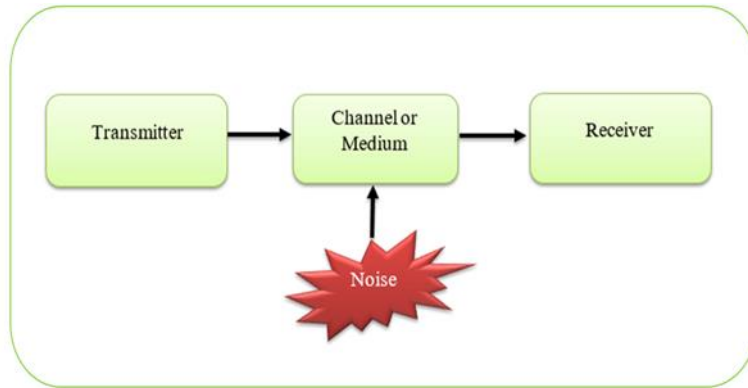

Figure 2.7. General model of communication system

Transmission is highly variable based on the formats and methods used, which depend on size, length, and required reliability of data transmission. Two main communication techniques in use are wired and wireless communication, Data can either be in digital or analog formats. Wireless is the mechanism needed for mobile vehicle-to-vehicle and vehicle-to-infrastructure communication. The potential for simultaneous communication is expressed by the class employed:

- Simplex*: Communication in one direction only
- Half-Duplex*: Communication is bidirectional, one direction at a time
- Full-Duplex*: Communication is simultaneously bidirectional

**2.12.5 Wired communication.** Infrastructure nodes typically communicate using wired techniques. This provides low cost, high bit rate communication channels to support base stations and for connecting to Internet backbones. The highest bit rate available is over fiber optic communication channels. While not strictly “wired,” optical techniques are analogous to other wired techniques in that they require (optical) cables

between transmitter and receiver. Other advantages of fiber optic technology include resistance to signal interference, reliable long distance communication, and a lower security risk than other methods. Several techniques have been developed to address security. One such technique is optical steganography, which provides ways to hide private data within a public channel [21].

**2.12.6 Wireless communication.** Wireless communication is one of the most active areas in communication technology. It is essential to deliver ITS functions including vehicle-to-vehicle and vehicle-to-infrastructure services. The rapid growth in the IoT has required equivalent growth in connectivity. The continuing evolution of semiconductor technology offering higher speeds, lower power, and higher densities, means that complete systems-on-chip (SoC) architectures are now available where an embedded processor –or processors— are directly integrated with supporting communication subsystems such as Bluetooth, Wi-Fi, or others. Design advances in wireless systems has increased the reliability and flexibility of air interfaces with reduction of fading and interference impacts.

**2.12.7 Bandwidth and data transmission.** One of the key considerations in a communication system is the spectrum occupied by signals. The term bandwidth in communication systems refers to the portion of the spectrum that a signal and the associated communication technique require in order to achieve the required bit rates and error rates. Bandwidth is briefly defined as the difference between the upper and lower frequencies of a signal. The aggregation of all vehicle sensors such as radar, cameras, GPS, etc., will define the total bandwidth required [22].

**2.12.8 Vehicle-to-Vehicle communication.** V2V is a distributed system of wireless communication to support intelligent traffic management, information services, and vehicle control. Vehicles will be equipped with DSRC radios to communicate and exchange data through Basic Safety Messages (BSMs), which are standardized messages sent at a rate of 10 messages/s between each vehicle and its nearest neighbor vehicles.

Fig. 2.8 depicts the nodal view of a physical transportation network.

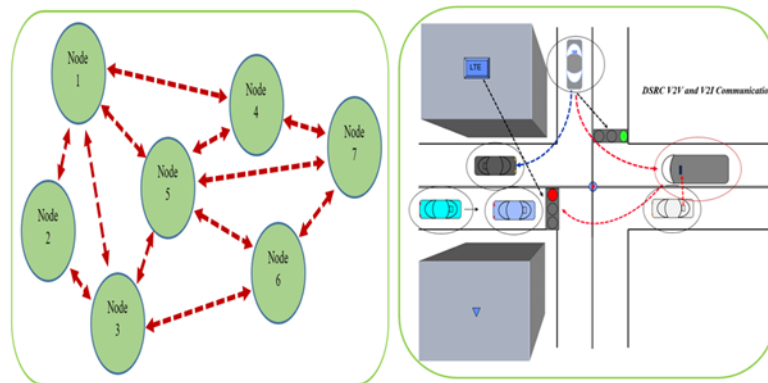

*Figure 2.8. DSRC V2V and V2I communication*

**2.12.9 Vehicle-to-Infrastructure communication.** Vehicle-to-infrastructure communication shares many attributes of vehicle-to-vehicle communication in that both are based on wireless technology. Communication established between vehicles, roadside units, and other devices in the network allow for exchange of safety messages. Much research has focused on the means to provide efficient warning systems. Raut, et al.,[23] proposed a scheme based on lane departure detection as the basis for reducing chances of collision. A RSU continuously monitors all vehicles within its sector and tracks them. This is important in high vehicle density situations when VANET is not able to

adequately track vehicles. Multiple algorithms already developed such as traffic light control for collision avoidance, such as described by Hsu, et al. [24]. This algorithm provides roadside units and vehicles with sets of rules to manage incoming vehicles that enter communication range with roadside units as suggested by Fig. 2.9. V2V and V2I systems key elements should include a mixture of Vehicle On-Board Units (OBUs), RSU, and supporting communication channels. The OBUs are on the vehicle side of the communication system and have practically the same subsystem elements as V2V seen figure DSRC Infrastructure on-board unit. The architecture defined below describes V2V and V2I equipped devices. Developers can have architecture design, but the goals will remain and establish the same effective communication between units.

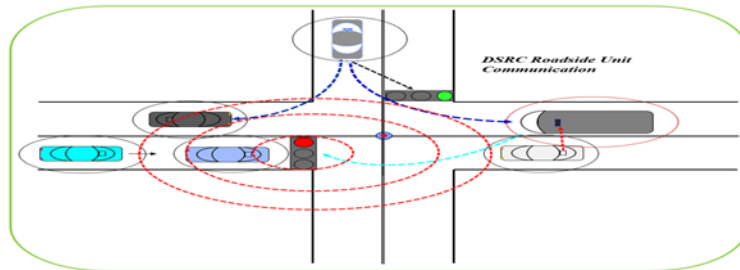

Figure 2.9. V2V and V2I environment.

**2.12.9.1 DSRC Communication Architecture.** Fig. 2.10 shows the block diagram of a basic DSRC communication system supporting a vehicular application for ITS. The DSRC radio transceiver is the central component, which provides the means to support safety applications and to provide traffic flow and travel time information to surrounding vehicles and central nodes. Wireless communication devices are also connected to a computer interface. V2V communication is supported in order to update vehicle node

tables as well as to communicate to surrounding vehicles. A human-machine interface (HMI) provides interaction with the driver to display information such as speed, temperature, alert zones, GPS data, and other standard map functions such as points of interest. The onboard network connects the suite of internal devices, sensors, computer elements, the DSRC transceiver, etc. For devices that do not have wired network interfaces, wireless techniques (Bluetooth, Wi-Fi, etc.) establish communication between those elements. There are a number of different types of communication techniques used between devices and the central computer. Some devices stream data (GPS receivers) or report data at predefined intervals (lane avoidance); others report data only when polled (temperature); still others can have event thresholds set to define when data is transmitted (collision avoidance distance) to avoid excessive data traffic.

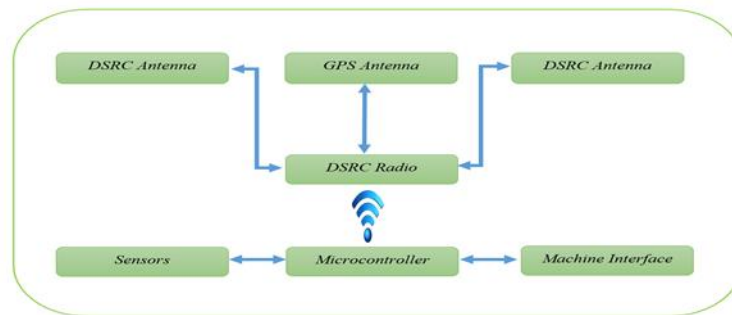

Figure 2.10. DSRC communication infrastructure

**2.12.9.2 DSRC Message Set.** DSRC is intended to meet the requirements for applications that depend upon transfer of V2V and V2I information. Communication consists of two different modes: (i) Direct communication occurs between vehicles entering into a usable communication zone with fixed roadside equipment, and (ii)

Indirect communication via collaborating nodes to move data to the intended destination. SAE J2735 defines the interoperability means among DSRC applications through the use of standardized message sets [25]. The SAE J2735 standard defines the details of the message, data frames, and data elements for data exchange between vehicles and other nodes. There are multiple type messages. Five of the most important include:

- Basic Safety Message (BSM)
- Probe Vehicle Data Message (PVDM)
- Traveler Information Message (TIM)
- Map Data Message (MDM)
- Single Phase and Timing Message (SPaTM)

**2.12.9.3 Basic Safety Message.** BSM is the core message in a vehicular environment, which consists of several data elements including vehicle size, position, location, and speed. This type message is periodically broadcast to surrounding vehicles and classified into priority and non-priority messages. To process the data, the encoded messages are sent hierarchal messages using a combination of encoding rules. The encoded priority BSMs are encoded using the coding rule of Abstract Syntax Notation One (ANS.1) and transferred from the sending endpoint to the destination. Less priority messages for instance the internet, video are sent when needed; their content varies according to the nature of the information [26]. Some BSM application examples include emergency braking, pedestrian warning, forward collision warning, lane change assist, left turn assist, do not pass warning, etc. Part II of BSM can provide updates for a vehicle

safety system and are sent when needed and with varying content. For instance, an event trigger word can be sent to indicate a violation such as Do Not Stop sign detection of various events.

**2.12.9.4 Probe Vehicle Data and Traveler Information Messages.** PVDM and TIM are messages important to situational awareness useful to vehicular infrastructure integration [27]. These messages deliver vehicle data sets collected by the OBU of each vehicle and are delivered to an RSU when passing within its range. The DSRC message set also provides for control messages sent from the RSU to the OBU to regulate what data is to be collected and reported.

**2.12.9.5 Single Phase and Timing Message and Map Data Message.** The SPaTM message type is proactively broadcast by RSUs to provide phase timing data for one or more signalized intersections. Its function is to inform drivers of the status of the traffic signal ahead as well as when the next signal stage will occur in the current path [28]. The MDM supports geographic position status on roadways, which can also be linked via a SPaTM message to reduce timing and positional uncertainties—for example, which lane the vehicle occupies, as intersections are approached.

**2.12.10 DSRC applications.** In V2V applications, the basic safety message (BSM) is the critical message. It provides vehicle real-time information to a set of neighboring vehicles over a range of 300-500 meters, which is dependent on the make/model of DSRC unit. Table 2.2 summarizes DSRC applications.



Table 2.2

*DSRC Application Mobility and Environment*

V2V Safety Applications	V2I Safety Applications
Application Enabled by BSM	Application Enabled by SPaT/MAP
Forward Collision	Red Light Warning
Electronic Brake System	Left Turn
Lane Change Warning	Right Turn Assist
Intersection Collision Warning	Pedestrian Signal Assistant
Cooperative Adaptive Cruise Control	Transit Signal Priority
Do not Pass Warning	Rail Crossing

**2.12.11 DSRC deployment concerns.** Large scale roll out of DSRC to potentially hundreds of millions of vehicles poses a number of concerns including: (i) Scalability, (ii) Privacy, (iii) Security, and (iv) Positioning uncertainty, among others. The scale of the problem is easily seen by considering a rush-hour scenario on a busy highway as shown in Fig. 2.11.

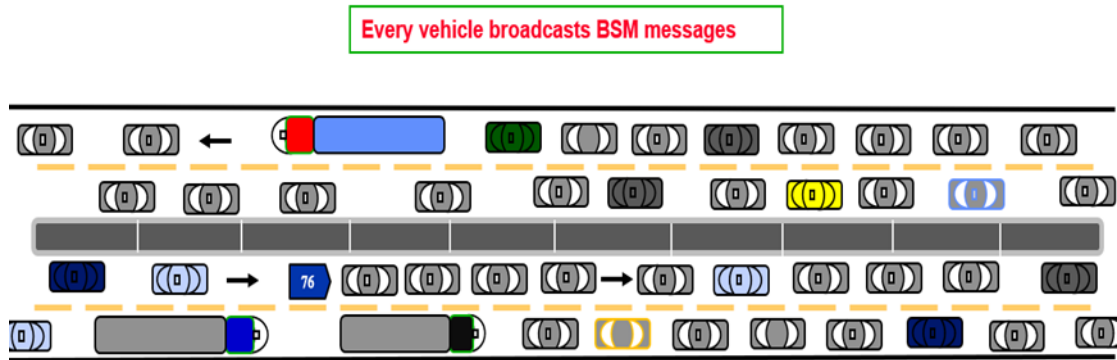

Figure 0.1: Scalability of basic safety messages

**2.12.11.1 Scalability.** Every second, each DSRC-equipped vehicle will be transmitting basic safety messages. Based on the default configuration, each vehicle will generate 10 BSM messages per second. Any limitations of available DSRC communication channels will affect network performance, and is particularly important once message saturation levels are encountered. Given the availability of the allocated seven, 10-MHz channels, when demand exceeds the channel capacity, there will be increased message latency as the DSRC radio performs channel switching and handshake operations, which will impact safety. To achieve the full benefits of DSRC, latency and channel capacity must be well understood to effectively manage thousands of vehicles on the road.

**2.12.11.2 Privacy.** Privacy is another issue and a key element of DSRC. To minimize the ability of a DSRC system to be an automated tracking tool, DSRC technology will not maintain vehicle information for long periods. In fact, DSRC supports well defined schedules that regularly refresh vehicle information including certificates, MAC addresses, etc. Thus, vehicle information will automatically “fade” from the DSRC system and must be periodically refreshed for a vehicle to still be considered a part of the ad hoc DSRC managed time- and spatially-related vehicles.

**2.12.11.3 Security.** Security is a serious issue. It is imperative that critical safety messages aren't maliciously interfered with through a number of means such as blocking the Radio Frequency (RF) signals or changing the data by either escalating or de-escalating emergency messages. The IEEE 1609 standard family has been developed to provide security in dedicated short-range communication applications. To exchange a secure message, two primary functions are required: (i) Authentication to show that the

sender is authorized, and (ii) Encryption to keep data secret using data encryption and decryption with corresponding security certificates.

**2.12.11.4 Positioning Uncertainty.** Another contributor to the overall success of ITS will be accurate knowledge of vehicle position and dynamics. Minimum positioning accuracy levels include: (i) Road level accuracy sufficient to determine “which road” a vehicle is traveling on, and (ii) Lane-level accuracy sufficient to determine which lane a vehicle occupies. Accurate position determination is a challenge even for regular GPS signals, which can be confounded by dense urban environments where buildings may block signals. Future improvements in global navigation satellite system (GNSS) performance will improve positioning, navigation, and timing (PNT) resolution and accuracy. The U.S. global positioning system (GPS) is one example of a widely used PNT system based on a constellation of approximately 30 satellites placed in medium earth orbit. There has been some progress made in reducing the positioning errors caused by selective availability (SA), which limits accuracy to commercial GPS users (meter resolution) compared to military users (cm resolution). Cell tower signals offer additional positional resolution to complement GPS. Rollout of 5G wireless technologies promises to bring cm resolution to mobile applications. However, 5G will remain as problematic as other wireless technologies in rural areas, where their availability is severely limited.

**2.12.11.5 Wireless Access for Vehicular Environments (WAVE).** Wireless Access for Vehicular Environments (WAVE) is an amendment to the IEEE 802.11p standard. IEEE 802.11p/WAVE defines wireless support to VANETs on the 5.9 GHz band [29]. WAVE provides the real-time traffic information needed to achieve the transportation safety and traffic de-congestion improvements sought by ITS. This

standard supports traffic data collection and transmission. It also provides information security. Real-time update of routing information provides drivers with route choices so as to potentially reduce travel time and associated costs. The open systems interconnection (OSI) model of the International Standards Organization (ISO) was developed to help uniformly deal with network complexities. The OSI model describes data communications by dividing functions into seven layers with each layer having well-defined functions. From a protocol viewpoint, the layers are treated as a stack within each network node. Communication between nodes can then be viewed as peer-to-peer communication between layers. That is, an Application layer effectively communicates with the corresponding Application layer of another node, even though to achieve that exchange, a message has to proceed down the protocol stack of one node—e.g., Application→Presentation→Session→Transport→Network→Datalink→Physical and then climb the protocol stack on the target node:  
Physical→Datalink→Network→Transport→Session→Presentation→Application.

Fig. 2.12 compares the protocol stack of IEEE 802.11/p-WAVE to the generic OSI 7-layer model. In OSI model, the data link layer is described by two main sublayers MAC and Logical Link Control (LLC) to control data flow.

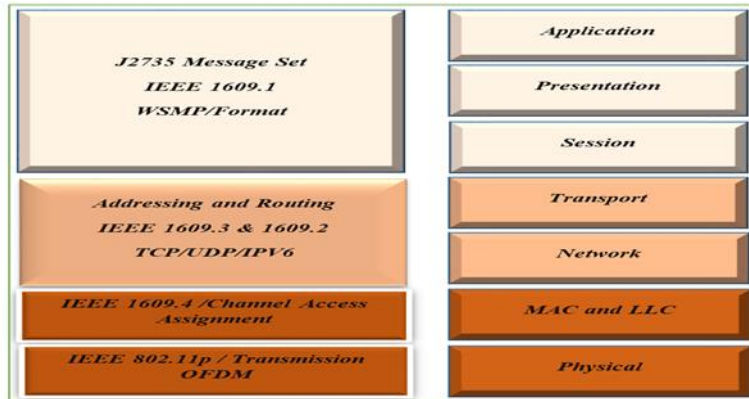

Figure 2.12. Compares the protocol stack of IEEE 802.11/p-WAVE to the generic OSI 7-layer model.

Problems frequently encountered in networking include message order, multiplexing, and de-multiplexing, routing in the network layer, and bandwidth. WAVE adapted the OSI model and defines the layers important to achieve the ITS goals. The WAVE Physical layer moves data across a transmission medium. It is responsible for the movement of an individual bit from node to node via wired or wireless means. WAVE Medium Access Control (MAC) supports network and transport layer functions via the WAVE Short Message Protocol (WSMP) and using the familiar IPv6 TCP/UDP protocols. WSMP based on 1609.3 has been developed to avoid excessive overhead and collision. It is a short message primarily intended for safety messages; and can be sent only through the control channel. Fig. 2.13 depicts the protocol stack model for WAVE.

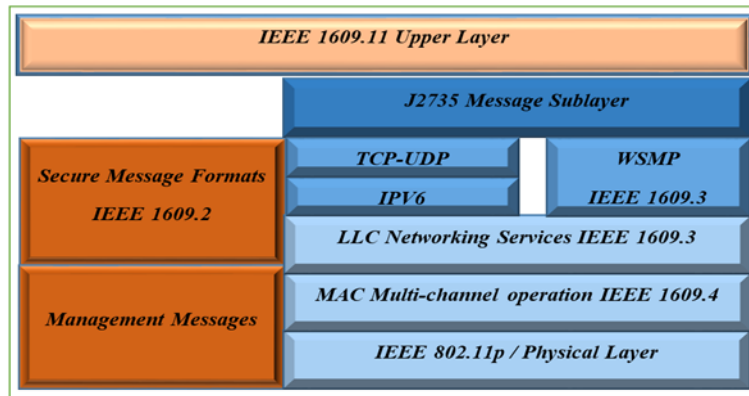

Figure 2.13. DSRC protocol stack.

**2.12.11.6 Example DSRC Unit.** For the work undertaken in this thesis, an example DSRC unit was available. The radio system was an Arada Systems LocoMate™, which is based on Wi-Fi and has the 5.7 to 5.925 GHz frequency band configurable into 10 MHz or 20 MHz channel bandwidths. Fig. 2.14 shows the Arada unit. GPS is also integrated into the unit, which makes it possible to support both V2V and V2I applications. Software for the platform is Linux based. UDP is among the network protocols supported, which was used to establish communication between a central node and a roadside unit.

**2.12.11.7 User Datagram Protocol (UDP) and Internet Protocol IP.** UDP is one of the core members of the Internet Protocol (IP) stack. IP defines a set of message formats and the rules for exchanging data between nodes. UDP is a connectionless transport protocol that transmits packets from a source to a target destination address. TCP/IP is another IP member, which provides end-to-end packet assurance, but was not used in this work. In the case of DSRC network nodes, UDP can handle communication between two DSRC units with each unit having a specific 16-bit port number assignment.

An advantage of UDP is the minimum of protocol overhead required [30]. Unlike TCP/IP as noted above, this protocol does not provide reliability of delivery because there is no explicit acknowledgement when packets are received. For the Arada DSRC unit, the data received over the UDP is in ASCII format, which simplifies message parsing.

**2.12.12 Mobile data collection and dissemination platform.** Using a vehicle as an IoT node, the DSRC unit collects and forwards data through its channel to surrounding equipment. Fig. 2.15 summarizes how data collection and dissemination are generated over the reserved channel. In this thesis, new methods are proposed for collecting and disseminating data in a vehicle node. The system uses several protocols to disseminate data. Algorithms including vehicle detection according to Tian, et al., [31] was incorporated for the mobile data collection system. Additionally, mechanisms for data collection and dissemination include prioritization of certain data such as traffic count during incidents, environmental road conditions, and pavement condition.

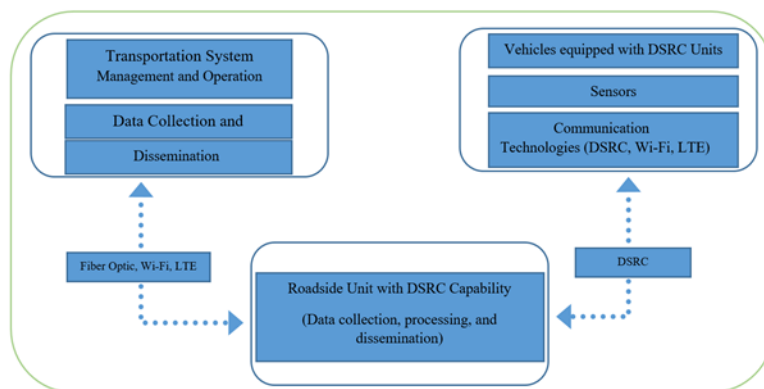

Figure 2.14. Mobile data collection and dissemination platform.

**2.12.13 Communication interface and vehicle subsystems.** The vehicle communication system is responsible for transmitting and receiving data and supporting the driver interface. Similar to the basic DSRC structure, the vehicle subsystem components include an Omni-directional antenna, DSRC OBU, GPS receiver, sensing devices, and a computer or microcontroller as shown in Fig. 2.16. This thesis work employed a Raspberry Pi B+ to provide data collection from the sensor suite and relay this data to an Android tablet using LTE communication. Sensor status is reported to the driver using the Hypertext Transfer Protocol (HTTP) Get- and Push-functions.

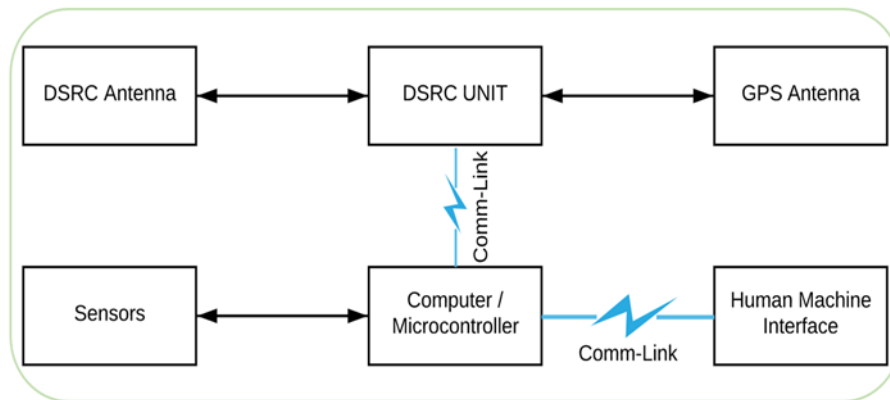

Figure 2.15. Vehicle Communication Subsystems

## 2.13 Wireless Sensor Network Applications

One of the motivations for use of wireless sensors is collaborative work with an IEEE P1451.1 development group. The IEEE 1451.5 standard includes many wireless communication methods including Bluetooth, Wi-Fi, and ZigBee. Wireless protocols are



also of interest for applications involving hazardous area monitoring. An important emerging area is precision agriculture, which makes extensive use of wireless sensors and many of the core communication elements important to ITS. A wide variety of sensors are available as wireless versions, and it is straightforward to add a wireless interface to existing sensors so that their data can also be forwarded to a central node. In this thesis, a wireless sensors network supports mobile data collection and dissemination from vehicles nodes equipped with different sensors for collecting road status, location, and path. Each vehicle has the capability to propagate information to surrounding vehicles and route them to a Transportation System Management & Operations (TSM&O) center.

#### **2.14 Summary**

This chapter discussed the important background principles and technologies including communication types and standards. Key challenges were identified including channel congestion and energy consumption issues. The next chapter focuses on previous research approaches to energy consumption and channel congestion to guide selection of appropriate research methods.

## Chapter 3

### Energy Consumption and Congestion Control Algorithms

This chapter discusses previous work related to energy consumption and vehicular channel congestion algorithms. It also underscores the key challenges of efficiently handle network congestion and sensor energy consumption, which provide the motivation for the ensuing thesis work.

#### 3.1 Energy Consumption Issues in Wireless Networks

This section focuses on the energy consumption in sensor networks. In the case of vehicles, it may be counterintuitive that there could be an energy problem due to the availability of high capacity 12V battery sources. However, as the number of sensors on the vehicle increases, power budgets become more important, and the desire to make sensors wireless to simplify interconnect wiring means that sensor power budgets are even more critical. Accurate prediction and monitoring of energy consumption is therefore a key consideration for vehicular ad hoc networks.

There have been several models of energy consumption proposed for sensor networks. Halgamuge, et al., [32] proposed an estimation method for sensor energy consumption. Their method evaluated energy consumption of a sensor by focusing on sensing, logging, processing, transmission, and actuation energy dissipation. A shortcoming of this model is that it fails to account for all the modes of energy consumption, which can be substantial. For example, the idle time for a sensor system

may occupy a substantial portion of time, and can account for a large percentage of energy consumption.

Razzaque and Simon, [33] described energy-efficient sensing in a sensor network. The technique focused on compressed and distributed sensing for sensors. Although their model identified a variety of energy consumption types, the total amount of consumed energy remained unknown. This uncertainty is primarily due to fundamental differences in sensor operation, which results in many differences in energy consumption. Most sensors consume the highest amount of energy when they are actively performing their core sensing functions while others may use the most energy during initialization or when storing data. Fabian, et al., [34] showed the power consumption of a Wi-Fi interface during upload to vary between 71-83mW for the power consumption of the raspberry pi, which is substantially more than the nominal power budgets of a few mW for a typical sensor. Since communication is a key part of the energy schedule for wireless sensors, high transmitter power results in substantially shortened energy lifetimes.

Because the uncertainties in energy consumption are not well controlled in the reviewed literature, this remains an important issue and is addressed in this thesis. One of the key innovations is to propose maintenance of energy reserves in order to allow a node to communicate critical data to a collection node under high priority emergency conditions.

## 3.2 DSRC Channel Congestion

The network congestion problem occurs when the number of data packets present in the channel exceeds the channel capacity. Congestion begins when the added data, messages, or vehicles occupy a certain channel. This leads to channel saturation and results in data loss.

**3.2.1 Channel congestion control problems.** The DSRC application can be configured to transmit a Wave Short Message Protocol (WSMP) at different data rates as shown in Table 3-1. Variable data rates are available depending on the channel bandwidth. IEEE 802.11p designed for DSRC uses a bandwidth of 10 MHz with different data rates in order to maintain reliable communication for safety application when multipath and fading happen in the networks. On the other hand, IEEE 802.11a uses the data rates up to 54 Mbps with a bandwidth of 20 MHz.

Table 3.1

*Data Rate Supported at 10 MHz*

Frequency	Data Rate Mbps
10 MHz	3.0 4.5 6.0 9.0 12.0 18.0 24.0 27.0

The Arada LocoMate Unit can transmit WSMP data from 3-27 Mbps depending on what bit rate a user needs. Wave base subscriber station (WBSS) management is used to initialize the register and callback functions by opening the WAVE driver for receiving data. To make a demonstration of a DSRC (RSU and OBU),

LocoMate has an integrated default application “getwbsstxrrencdec” to provide different messages. Transmit and received methods are configured using key authentication. The following command is an example of BSM from one vehicle to surrounding vehicles.

- `getwbsstxrrencdec -b 178 -s 180 -t BSM -o norx -y 34 -r 6.0 -d 50`

This command describes a transmitted BSM, which is encoded in Distinguished Encoding Rules (DER) on control channel 178 at 6 Mbps every 50 seconds. The term “norx” means to transmit data only. The character “b” selects the transmit channel, “s” selects the service channel, “y” is the provider service identifier and “d” specifies the message delay.

A significant number of vehicles sending BSM traffic could saturate the communication channel contributing to packet loss in the network, which in turn causes delays or phase shift in the network. This defeats the main reason for using DSRC in the first place, which is due to its low latency. This research focused on the BSM which is the most fundamental building block that enables proximity awareness per IEEE WAVE [35]. So the means for providing higher confidence in achieving low latency BSM messages needed to be investigated considering instantaneous traffic parameters including traffic flow, density, and travel time.

**3.2.2 Previews of congestion control techniques.** Many approaches have been employed and investigated as potential means to handle congestion. SAE J2945/1 uses a congestion control algorithm when the channel is saturated. The algorithm runs on each of the OBUs via adaptation of the transmission power [36]. SAE J2945 standard is designed to solve the channel congestion issue by reducing the transmission frequency

and power [37]. Kenney, et al., [38] defined a new congestion control technique applied to the message rate of mobile devices. The technique called: A Linear Message Rate Control Algorithm for Vehicular DSRC Systems to provide a significant improvement in channel congestion by avoiding the fairness issues, which results in stability as the numbers of vehicles increases. Subramanian, et al., reduced vehicular congestion by making changes in the data reception technique [39]. Their “decentralized congestion algorithm” successfully performs packet reception with high vehicle density. The algorithm is based on synchronous and asynchronous when medium access control faces high densities. When congestion is occurred, they constructed a synchronous time division multiplexing overlay on the MAC without violating the DSRC standard. The concept of the overlay is to provide a frame structure on top of IEEE 802.11p in a deterministic way. One drawback of the decentralized algorithm is potential computational bandwidth limitations of the onboard computing devices to process data, which still can result in packet loss. This competes with other simultaneous tasks such as cryptographic verification of packets [40].

**3.2.3 Study research questions.** The literature review shows that many questions remain as to how to best control congestion and travel time. While the two forms of congestion are strongly linked, the best ways to differentiate roadway traffic congestion from communication network congestion need to be determined. It is important to determine the best way of estimating network congestion and the number of vehicles that cause congestion. As density increases, scalability is a main issue. To address these questions, DSRC technology employing Wi-Fi working with LTE may be an effective way to solve such problems.

### 3.3 Long Term Evolution (LTE) Technology

The growth in data-intensive mobile services and applications is the principal driving force in the development of next-generation wireless standards [41]. Third-generation wireless partners developed LTE as the next step in achieving high data rates, low latency, and packet optimized radio access without dramatic changes in backbone technologies [42]. LTE is an obvious choice for a communication partner to complement DSRC in ITS applications. DSRC can be focused on the safety applications, while LTE can be applied to address non-safety applications such as traffic information, internet access, etc. [43]. Importantly, however, cooperation between the two technologies can help solve the packet dropping problem. Fig. 3.3 shows the potential interplay between DSRC and LTE. If the DSRC link is unavailable for the V2V link shown, and there is no roadside unit available for relay, packets could still be conveyed using LTE.

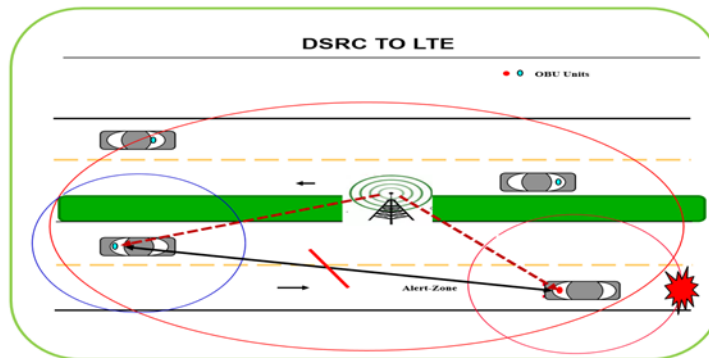

Figure 3.1. LTE Long Range Communication

### 3.4 Routing Strategy and Dijkstra Algorithm

The classic traveling salesman problem has motivated the development of many algorithms that solve the problem in such a way as to provide shortest path, fewest stops, least amount of energy, or meet other criteria. The shortest path finding problems are solved using different algorithms such Bellman Ford, Dijkstra, Floyd Warshall, and Johnson algorithms. Dijkstra's algorithm is most important because of the method used to solve the shortest path problem with non-negative weights. Among multiple Dijkstra's algorithms, Khaing, et al., [44] used Dijkstra's algorithm for public transportation system to provide critical information of the route. Their algorithm calculates the best path that minimizes cost and travel time. The Dijkstra algorithm has been found to be one of the most optimum solutions [45]. The algorithm computes the length of the paths from a starting point to each possible vertices. This thesis research uses a routing strategy based on the Dijkstra algorithm as a means for reserving critical levels of energy to ensure a vehicle can transmit safety-critical data to a desired destination.

The route choice algorithm considers reserve energy of the vehicles. For the graph shown in Fig. 3.3, Dijkstra's algorithm designates the distance label to each node, which is the path cost [46]. Thus, to reduce energy consumption, the lowest-energy cost path needs to be determined as the optimal route for transmitting data to a destination.



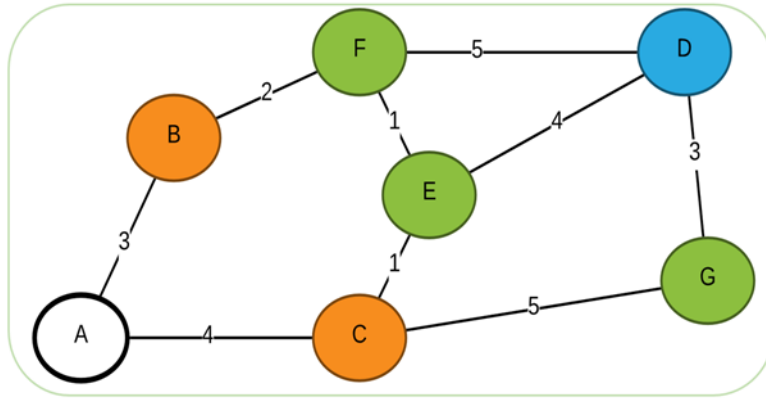

Figure 3.2. Optimal Path using Dijkstra's Algorithm

### 3.5 Summary

A literature search related to energy consumption, traffic congestion, and network congestion was completed. An important finding is that while there have been numerous approaches suggested to solve network congestion problems, many of the approaches are not optimal. The challenge remains unanswered about how to best ensure delivery of safety-critical messages under adverse conditions of high traffic congestion and high network congestion. The following chapter provides a new method and algorithm to detect and minimize network congestion by combining DSRC and LTE technologies.

## Chapter 4

### Methods

#### 4.1 Introduction

In order to address the energy consumption and network congestion problems presented earlier, this chapter explains the methods and research approach utilized to develop and evaluate more optimal algorithms. Although traffic congestion is mentioned, it is not the focus of this work. The chapter, therefore, is divided into two sections. As presented in the figure 4-1, the first section (4.2) both explains the energy consumption algorithm developed in this study and also discusses the laboratory experiments conducted to evaluate it. The subsequent section (4.3) describes the experimental setup of energy consumption optimization, including the Dallas DS18B20 sensor, the Raspberry Pi 3, the INA219 current meter, and batteries (Ravpower and 9V). Section (4.4), introduces the additional problems of network congestion by discussing a congestion control algorithm which is focused on alternating between DSRC and LTE protocols to re-route the Basic Safety Messages (BSMs). Evaluation results and discussion for both sections are presented in chapter 5.

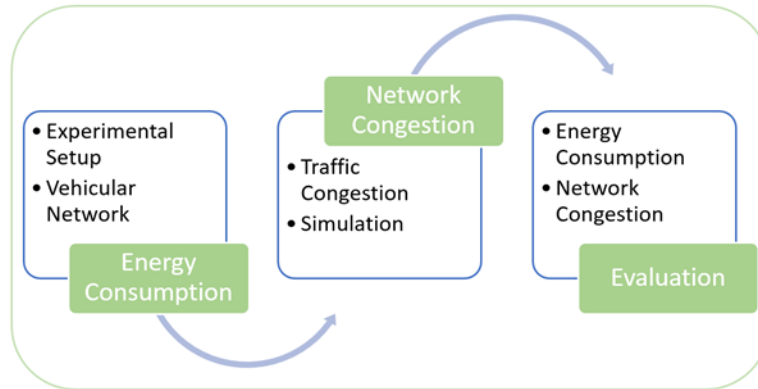

Figure 4.1. Methods to evaluate energy consumption and network congestion

#### 4.2 Energy Consumption Optimization Algorithm

This section discusses the energy consumption optimization algorithm and experimental setup utilized to test the algorithm.

Future transportation systems will include connected, autonomous, and connected-automated vehicles. While the autonomous vehicles will be connected directly with the central servers, each connected, and connected-automated vehicle of the future will be equipped with a DSRC unit, microcontroller and other sensors to remain connected with other vehicles and infrastructure units. The energy optimization for each sensor, then, becomes a critical task, in that every vehicle must maintain a reliable communication channel to broadcast basic safety messages in case of emergency. The following figure presents the mechanism utilized for energy consumption optimization. The pseudo code for the algorithm is presented in the subsequent section.

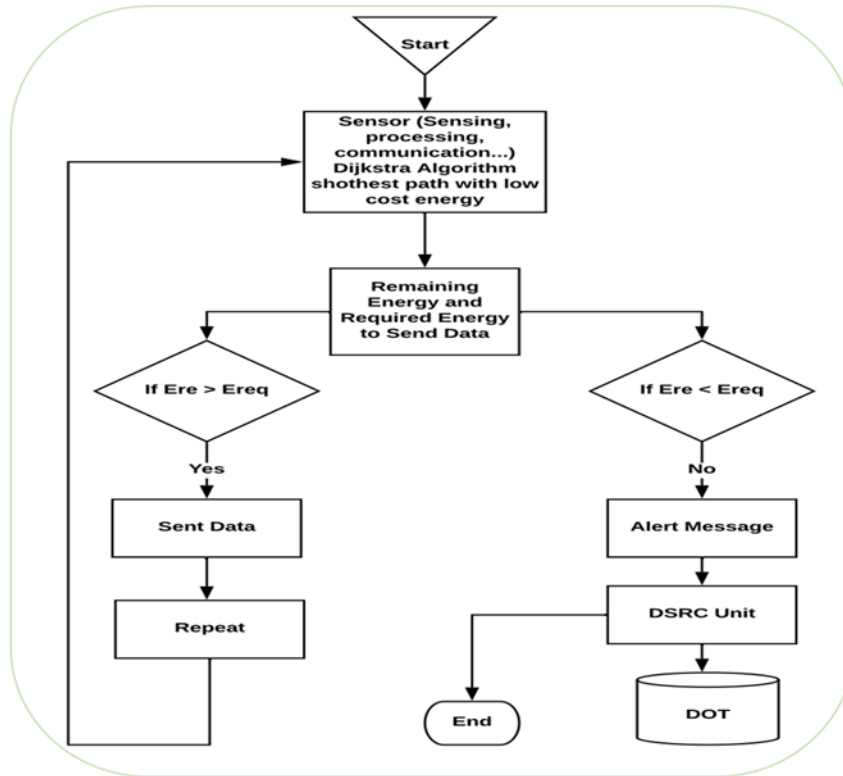

Figure 4.2. Flowchart of energy consumption.

**4.2.1 Energy consumption in vehicular networks.** The typical algorithm is processed and based on graph theory. The car under test will report its instantaneous remaining energy. This algorithm determines the minimum travel time and the energy required for a node to transmit data to the desired destination. In other words, the algorithm determines the remaining energy before sending new data to its neighbors. The figure below explains the goal and application of this algorithm. For example, say there is a set of vehicles {v1, v2, v3, v4, v5, v6, v7 ...} that forms a graph. In this situation, v1 might have only 10% remaining energy but needs to send data to v6 that has an energy cost of 15%. Obviously, v1 lacks the power to send data in the network. Because the required energy to transmit data is more than the remaining energy; v2 must use a routing

strategy that costs less than 10% to reach the destination. The choice of route can be either vehicle to vehicle or vehicle to LTE. V1's lack of energy may contribute to vehicle and network congestion.

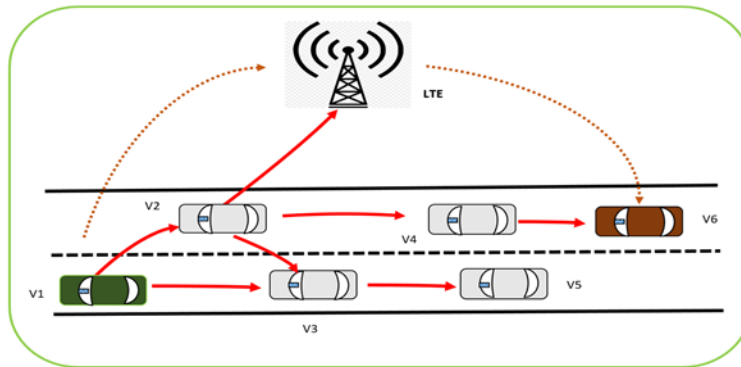

Figure 4.3. Vehicular energy communication and links energy

**4.2.2 Implementing Dijkstra's algorithm.** In order to alleviate this energy consumption problem, this study proposes Dijkstra's Algorithm as one part of a larger algorithmic solution. Dijkstra's algorithm seeks the shortest path from the origin to a destination; for example, from v1 to v6. It is necessary to know the energy cost for each edge from the origin to the desired destination. The steps to apply Dijkstra's algorithm for minimizing energy consumption include:

Process 1: Node Discovery

The algorithm starts by generating the list of surrounding vehicles, which is used to develop the complete graph of all vehicles and their communication links. The vehicle network graph is determined using a JavaScript, which runs on a Google Chrome

console. The discovered vehicle list is communicated directly to an origin vehicle. Once the nodes are discovered, the algorithm identifies the lowest energy cost nodes for routing.

#### Process 2: Link-cost

The second step in the algorithm is to compute all the link costs connecting all the vehicles in the current network. This captures the relative distances between all vehicle nodes.

#### Process 3: Energy Consumption Control

Energy consumption control provides the means to manage varying energy sources to ensure that a given vehicle node has awareness of the energy reserves that are available to achieve given sensing and communication tasks. Systems may have widely varying energy reserves such as typified by the example batteries used in this investigation. The first battery is a rechargeable Ravpower (Model RP-PB052) 22,000 mAh battery, which is specified to deliver up to 5.8A continuously. The second battery is a non-rechargeable, conventional 9V battery (Pikcell Model 6F22) rated at 480mAh. In the case of the 9V battery, the lifetime is strongly dependent on the discharge rate. Therefore, it is important to know the amount of power each element of a system requires in order to determine the total amount of energy that must be delivered from the battery.

**4.2.3 Algorithm energy consumption control.** The energy consumption algorithm is summarized in the pseudocode shown in figure 4-4. The detail JavaScript software for the congestion algorithm can be found in a GitHub [47]

```

1 Algorithm Energy Consumption Control
2   Input (volt, current, power, total_energy,node)
3   Output (dijkstra_graph, Required_Energy, Remaining_Energy)
4   current <-- getCurrent()
5   power <-- getPower()
6   dijkstra_graph (graph, start vehicles)
7   link_cost <-- unknown
8   start_vehicles <-- 0
9   Read Required_Energy
10  from Equation 6
11  Read Remaining_Energy
12  from Equation 7
13  While (all nodes find):
14    if Required_Energy < Remaining_Energy :
15      find vehicles with smallest cost and less multi-hop routing
16      Repeat Steps 9 and 11
17    if Required_Energy == Remaining_Energy:
18      Send Alert Message Low Energy
19    Else:
20      Stop Sending Message
21  Repeat
22  End

```

Figure 4.4: Algorithm for Energy Consumption Optimization

### 4.3 Energy Consumption Experimental Setup

The experimental setup to test the algorithm included a microcontroller, power sources and communication modules as shown in figure 4-5. The microcontroller is a Raspberry Pi 3 B+, which is responsible for general purpose input/output and maintaining communication. The energy consumption algorithm uses data from a temperature sensor (DS18B20). The battery under test is connected in series with a current monitor (INA219) to measure the instantaneous power flow to the temperature sensor. Data transmission is performed using Wi-Fi or Bluetooth technology. Each of these components is described in greater detail in the following subsections.

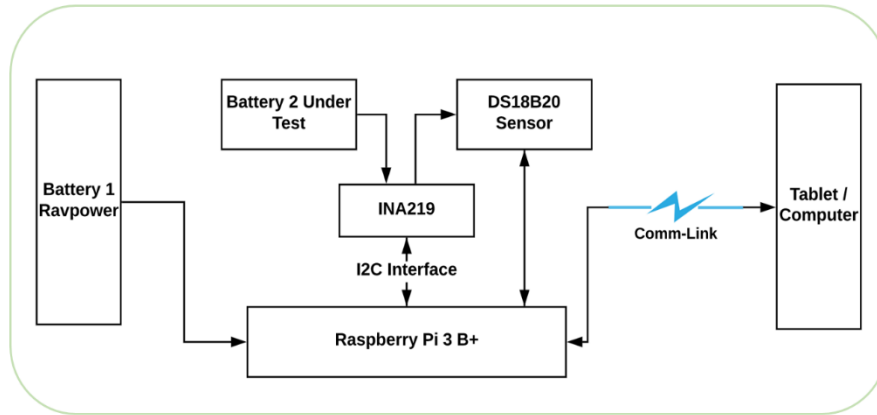

Figure 4.5 Experimental setup

**4.3.1 Power source.** The implementation uses Li-polymer (Li-Po) rechargeable batteries. This is due to the relatively high power requirements of the Raspberry Pi 3 B+, which can range from 1-2.5A. The particular Li-Po battery system employed (Ravpower, Model RP-PB052) can deliver an aggregate 5.8A total through three USB ports; however, each port is limited to a maximum of 2.4A each. Similarly, the charging port is specified to draw a maximum of 2.4A.

**4.3.2 Raspberry Pi 3 B+ and DS18B20 temperature sensor.** A number of generations of the raspberry pi are available; however, this research uses the model B+ because of its higher computational bandwidth. Specifically, the Pi uses the Broadcom BCM2837B0, which is a 64-bit system on a chip (SoC) operating at 1.4 GHz. Another important part of the raspberry pi B+ is its GPIO headers that connect the microcontroller to other devices and sensors.



To sense temperature, a digital temperature sensor (Dallas DS18B20) is employed with a temperature range from -100C to 850C at  $\pm 0.5$  accuracy. These sensors are relatively inexpensive. Interface between the microcontroller and sensor is based on the I2C bus.

#### **4.3.3 INA219 bidirectional current-power monitor and I2C communication.**





The INA219 is a current shunt and power monitor with an Inter-Integrated Circuit (I2C) interface [35]. It is powered by 3-5V. The function of the INA219 is to determine the energy consumed by the temperature sensor, which makes it possible to predict how much energy remains in the battery for supporting future data conversions and data transmissions.

The INA219 is connected in series with the battery under test and queried each second over an I2C interface to read the energy consumed by the sensor. The two bus interface lines, serial clock (SCL) and serial data (SDA) are connected to the respective Raspberry Pi B+ GPIO pins, GPIO5 and GPIO3. It is possible to expand the number of interfaced devices using I2C capabilities of supporting multiple devices [36]. The I2C master device drives the SCL clock; I2C slave devices respond.

Table 4.1 provides details for each of the components used in the experimental setup.

Table 4.1

*Components Used in Experimental Setup*

Device Image	Name	Purpose	Description
	Keyes Temperature Sensor	Representing all sensors on the vehicle	Supply Voltage: 2.7 to 5.5 V at 1.5 mA Operating Temperature: -25°C to 85°C
	Raspberry Pi 3 B+	Microcontroller that collects and transmits data	Microcontroller with dual band wireless running at 1.4 GHz, 2.4 GHz and 5 GHz wireless LAN, 1 GB RAM and 40 pins GPIO
	Adafruit INA219 Sensor Breakout	Current and power monitor and determine instantaneous energy consumed	The INA219 determine the remaining energy
	Ravpower Battery Model RP- PB052	Power for the microcontroller	Lithium-ion polymer Capacity 22000 mAh Input DC 5V at 2.4 A Three outputs combined maximum of 5.8 A
	Pikcell Model 6F22	Battery under Test	Extra Heavy Duty Zinc Chloride Battery Capacity 480 mAh Nominal Voltage 9 V

**4.3.4 Sensor energy consumption.** In wireless communication systems, energy consumption of the sensor suite is a major concern. There are many different ways to consume energy. In order to describe the algorithmic process, energy consumption factors must be identified for each subsystem and for each state of a subsystem. The Raspberry Pi B+ is powered directly by the mains during lab testing, or will be directly connected to vehicle power for extended testing. On power up, the microcontroller expends energy doing boot up activities, preliminary establishment of communication links, etc. Once the wireless communication links are activated, additional energy

consumption occurs. During routine operation, the microcontroller will periodically read sensor data such as from the DS18B20 digital temperature sensor.

By classifying the energy consumption factors into sensing, communication, and computation, the algorithm evaluates those three main energy consumption factors and reports it as Log10 values.

**4.3.5 Test process for energy consumption.** Mathematically, energy is defined as power multiplied by time. According to Razzaque and Simon [33], equations (1), (2), and (3) are used to calculate sensing, computational, and communication energy when a sensor is active.

Sensing energy,  $E_s$ , is thus

$$E_s = V * I * t \quad (\text{Joule}) \quad (1)$$

Where  $V$  is the sensor voltage,  $I$  is the current, and  $t$ , the time to complete a data sense and conversion.

- Computing Energy,  $E_c$

Computing the total computational energy,  $E_c$ , takes into account both active and idle time

$$E_c = V(I_{\text{active}} * t_{\text{active}} + I_{\text{idle}} * t_{\text{idle}}) \quad (\text{Joule}) \quad (2)$$

- Communication Energy,  $E_{com}$

$$E_{com} = V * I * T_d \quad (\text{Joule}) \quad (3)$$

In this case,  $T_d$ , is the time required to send data from the sensor to Raspberry Pi. The main energy consuming factor is the exchange of information from a source node to a destination node. The total energy consumption is defined as:

$$Ecom\_Total = Es + Ec + Ecom \quad (\text{Joule}) \quad (4)$$

Where  $Es$  is the sensing energy,  $Ec$  is the processing energy, and  $Ecom$  is communication energy.

The total energy used to sense, exchange, store, and perform other necessary actions is formulated as:

$$Eu = Ecom\_Total + \alpha * \sum_{i=1}^n \text{Log}_{10}(E_i) \quad (\text{Joule}) \quad (5)$$

Where  $Eu$  is the total energy used to relay data from the starting node to another node,  $\alpha$  is the factor exponent in  $(0, 1]$ , and  $E_i$  is the different types of energy consumed when a sensor is active, off, or in sleep mode.

**4.3.6 Remaining energy.** The remaining energy is calculated using data from the INA219 current sensor. Preliminary testing was completed using a LED and the INA219 interfaced to an Arduino. The second test used a Raspberry Pi 3 B+, a INA219, and a 9V battery. The instantaneous remaining energy,  $E_{re}$ , is expressed by the following equation:

$$E_{re}(t) = [Total\_Energy - Eu](t) \quad (\text{Joule}) \quad (6)$$

**4.3.7 Integrated systems health management.** Sensors involved in a measurement system raise considerations of calibration, reliability, and others.

Techniques developed in high sensor count, high reliability environments are appropriate to the vehicle sensor problem. In particular, Integrated Systems Health Management

(ISHM) addresses health management of complex systems and the components that make up the system. Core ISHM activity can include monitoring and processing sensor data to detect anomalies [48]. An ISHM systems for ITS needs to determine power source integrity, which includes the determination of remaining and instantaneous sensor energy consumption. One of the elements useful in an ISHM system is a health electronic data sheet (HEDS), which summarizes the nature of the faults that can be associated with a sensor, etc. HEDS are modeled along the lines of other IEEE 1451.4 transducer electronic data sheets (TEDS) that store the functional parameters of a sensor. Although preliminary work was begun on incorporating HEDS into this thesis work, it is most appropriate for follow-on expansion of the current effort.

#### **4.4 Congestion Control**

There are two varieties of congestion: Traffic congestion also known as vehicle congestion occurs when the number of vehicles exceeds a critical maximum density; the second type is network congestion or loading and occurs when the network communication channel is almost saturated. These types of congestion are interrelated. Strategies for solving network congestion can contribute to reductions in traffic congestion. For instance, if all vehicles are equipped with sensors, DSRC units, and GPS, the number of vehicles can be estimated based on the number of messages sent. To determine the number of vehicles in a distance ( $d$ ), which is known as density ( $K$ ), Greenshield's Model is used to predict and explain the trends in the vehicular network. One reason for using Greenshield's model is its ability to describe the relationship between density and vehicle speed. When speed is changing, BSM traffic also varies. The

stream model describes the interplay among speed, density, and flow, with respect to one another.

**4.4.1 DSRC networks congestion control.** The following figure presents the mechanism utilized for DSRC networks congestion control. The pseudo code for the algorithm is presented in the subsequent section.

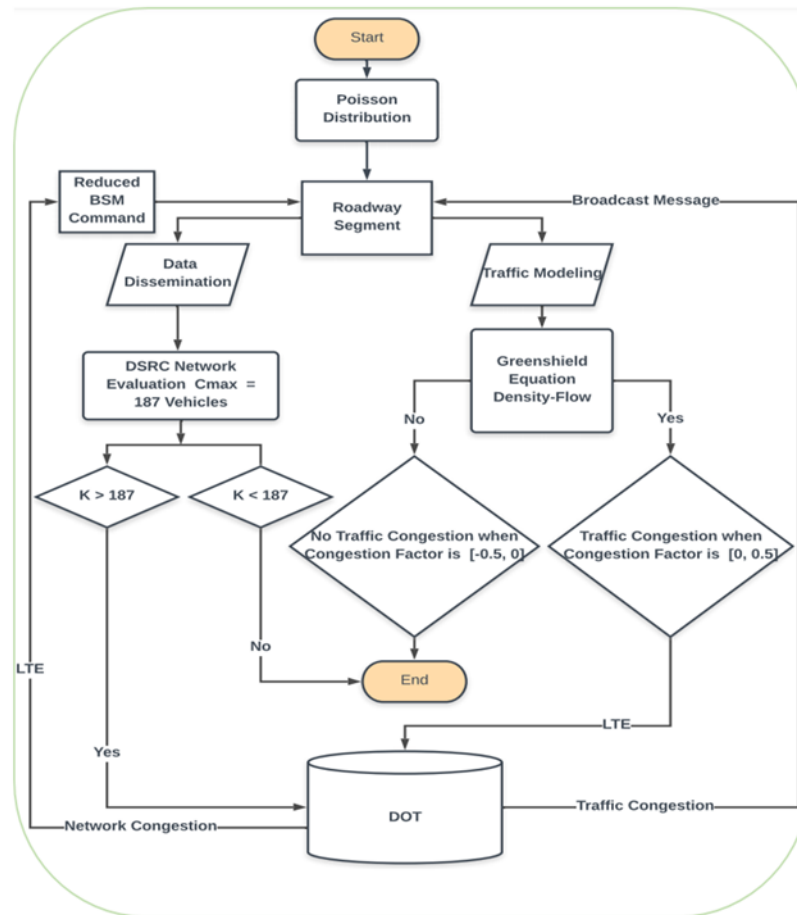

Figure 4.6. Flowchart of congestion control

**4.4.2 Algorithm DSRC networks congestion control.** The network and traffic congestion algorithm is summarize in the pseudocode shown in figure 4-6. The detail JavaScript software for the network congestion algorithm can be found in a GitHub [47].

```

1 ▾ Algorithm Network Congestion
2 ▾   Input (incoming-vehicles, speed, incoming-interval, congestion-interval,
3       DSRC-Channel, LTE-Channel)
4       Poisson-Distribution <-- incoming-vehicles
5       Default-Message-Size <--400
6       neta;
7   Output (BSM, Message-Size, DSRC-Channel-Capacity)
8   Leaving-interval <--incoming-interval + time-spend
9   Density <-- getCurrentDensity()
10  Flow <-- getFlow()
11  Equation 7 and 8
12 ▾  if Density < Equation 8
13     No Network Congestion
14     Send Default-Message-Size
15 ▾  else Density >= Equation 8
16     Optimisation (Minimize message size)
17     compute neta (Equation 22)
18     update Default-Message-size of each vehicle to Message-Size (Equation 23)
19     Broadcast Message-Size through the LTE
20     if Density >= Equation 8
21         Repeat(15, 16, 17, 18, 19)
22     End
23 End
24 End

```

Figure 4.7. Congestion control algorithm

**4.4.3 Evaluation of DSRC network congestion.** In a DSRC communication system based on IEEE 802.11p, the modulation technique can be Binary Phase Shift Keying (BPSK), Quadrature Phase Shift Keying (QPSK) which has 4 phases or 4 constellation states, or it can use Quadrature Amplitude Modulation (QAM) with either 16 channels (16-QAM) or 64 channels (64-QAM). Data rates vary over the range 3—27

Mbps based on the type modulation used. While QAM offers higher data rates, QAM is susceptible to noise, which can cause distortion and/or data corruption [49]. On the other hand, BPSK is more robust in noisy communication channels, but only supports lower data rates. The IEEE 802.11p standard defines 6 Mbps as the default data rate based on QPSK. The standard BSM message length defined by SAE standard J2735 is approximately 400 bytes with a message frequency of 10 messages per second. In V2X communication, the channel is uncongested whether the density is approximately equal to 187 vehicles [50]. The following equation defines the message capacity,  $C_{Msgmax}$ , of a DSRC channel using QPSK modulation.

$$C_{Msgmax} = \frac{\text{Data rate} \frac{b}{\text{second}}}{\text{Message Size} \frac{b}{\text{message}}} \text{Msg/s} \quad (7)$$

$$C_{Vehmax} = \frac{C_{Msgmax} \frac{\text{Messages}}{s}}{BSM \frac{\text{Messages}}{s \cdot \text{vehicle}}} \text{Veh} \quad (8)$$

For example, the message capacity for a 6 Mbps data rate channel with 400-byte messages yields a channel message capacity of 1875 messages per (7). Then for a BSM rate of 10 messages per vehicle per second, equation (8) computes the maximum number of vehicles before channel saturation as 187.

**4.4.3.1 Modeling.** In order to model the congestion processes for vehicle congestion and network congestion, the Poisson distribution is used in this thesis.

**4.4.3.1.1 Poisson distribution.** The event of incoming vehicles occurs in  $t = 0, 1, 3, \dots, n$  intervals.  $\lambda$  is defined as the average number of vehicles arriving into a roadway segment. There is  $\lambda$  occurrence in the selected time interval  $t$ . In another word, it is the



expected rate of occurrence of the event in interval  $t$ .  $P(X)$  is the probability distribution of  $X$  of  $K$  events in the interval, and it is calculated using the equation (9).

$$P(X = K) = \frac{(\lambda)^K e^{-\lambda}}{K!} \quad (9)$$

$X$  used Poisson distribution to model the incoming vehicles. It is the number of vehicles arriving in a specific time interval  $t$ .

**4.4.3.2 Network congestion control experimental setup.** One way to model network congestion for a segment of roadway uses a probability distribution to describe vehicles entering the roadway segment of interest. Incoming vehicles are modeled using the Poisson distribution that describes the probability of a vehicle entering the segment. In fact this is a queuing theory problem that can model arrival and service times. All vehicles are part of a series with “first in first out” (FIFO) behavior. Thereby, it is necessary to determine the relationship between the free-flow speed, density, and the average speed. This research uses the Greenshield’s mathematical model of traffic flow to demonstrate where congestion starts and to determine maximum vehicle density.

**4.4.3.2.1 Modeling highway traffic.** Greenshield’s equation relates predicted vehicle speed,  $V$ , to the effects of instantaneous vehicle density,  $K$ , and jam density,  $K_{jam}$ , as shown in (16).

$$V = V_f \left(1 - \frac{K}{K_{jam}}\right) \quad (16)$$

Understanding vehicle speed should help inform efforts to quantify network congestion of DSRC basic safety messages.

4.4.3.2.2 *Travel time.* Travel Time (TT) can be defined as the time spent driving from one point to another.

$$TT = \frac{\text{Distance } (d)}{V \text{ (Speed)}} \quad \text{(Second)} \quad (17)$$

Given roadway segment length,  $d$ , and the average speed,  $V$ , obtained from Greenshield's equation.

4.4.3.2.3 *Traffic flow and density relationship.* Figure 4-5 shows congestion as a function of traffic flow and vehicle density. Traffic flow is defined as the number of vehicles passing a specific point per unit of time. The traffic flow equation is:

$$Q = K * V \quad \text{(Vehicles/Hour)} \quad (18)$$

Where  $Q$  is traffic flow (vehicle/time) and  $V$  is the mean speed.

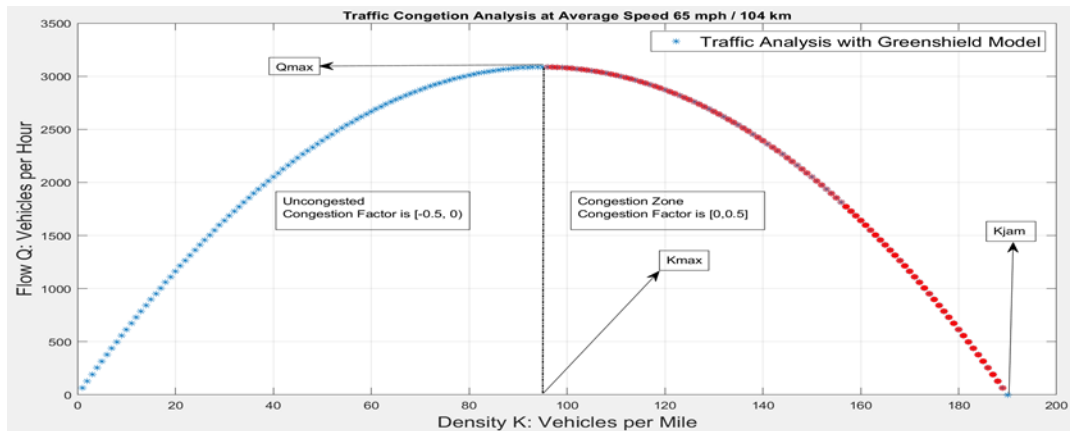

Figure 4.8. Relationship between Flow and Density

As seen on the graph, point  $Q_{max}$  is the maximum value of flow,  $Q$ . By substituting the mean speed into the traffic flow equation (18), the boundary condition can be derived, making it possible to find the maximum vehicle density,  $K_{max}$ , to avoid congestion on a given roadway segment.

$$K_{max} = \frac{K_{jam}}{2} \quad (19)$$

$K_{jam}$  is the jam density (vehicle/distance).

4.4.3.2.4 *Traffic congestion factor.* A road is considered to be congested when the average speed of traffic is less than 40% of the speed in unrestricted conditions over more than half of its total length [51]. For purposes of simulating Congestion Factor (CF), this thesis assumes a maximum density,  $K_{max}$ , of 95 vehicles and a jam density,  $K_{jam}$  is 190 vehicles. Addition of new vehicles in the roadway segment increases congestion. This relationship is shown in equation (20-a) where  $X$  vehicles are now in the roadway segment.

$$CF = \frac{X - K_{max}}{K_{jam}} \quad (20-a)$$

CF will vary between  $-1/2$  to  $+1/2$  as shown in (20-b).

$$CF \begin{cases} [-0.5, 0), & \text{Uncongested} \\ [0, 0.5], & \text{Congested} \end{cases} \quad (20-b)$$

4.4.3.2.5 *Traffic congestion analysis.* The model proposed in section 4.4.3, used a generalized polynomial model for the flow (Q) and density (K) function, which satisfy the congestion boundary conditions. By analyzing the figure below, the red curve describes the congestion state of when the speed at  $V_{jam}$  equals zero. To solve the traffic congestion, this research proposes an algorithm based on combined technologies of DSRC and LTE to inform the congestion of a specific roadway segment to all incoming vehicles. The figure 4-8 is showing the result of the congestion algorithm compare to a road congested.

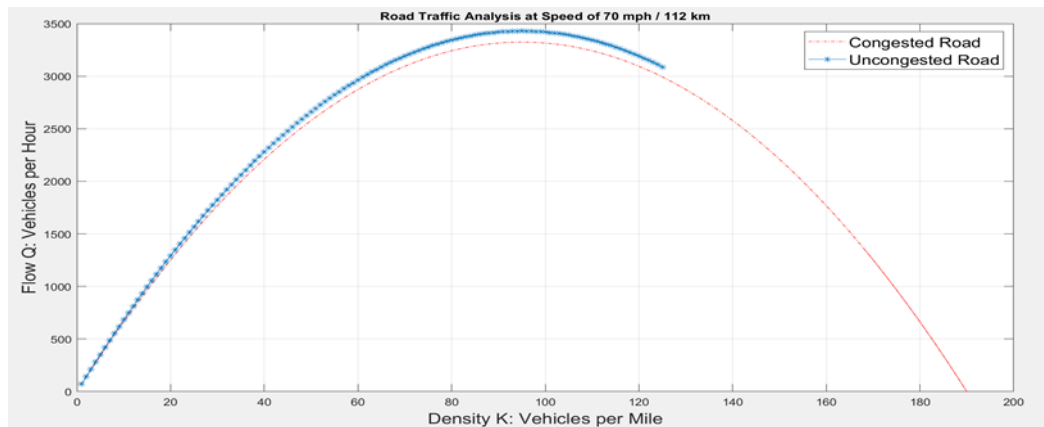

Figure 4.9: Traffic Congestion State and Congestion Control State

4.4.3.2.6 *Simulation.* These plots are the results of the algorithm used to control the traffic congestion at different vehicle speeds. Typically with lower speed, the flow has minimum values. This is because of the relationship between flow and traffic density.

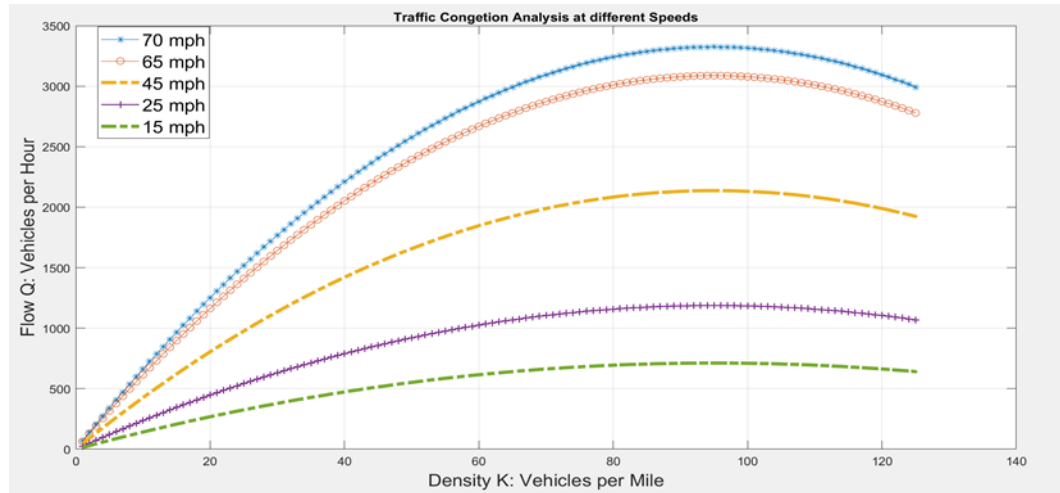

Figure 4.10. Traffic congestion as a function of speed

The following section will provide the results on networks congestion. With sufficient number of vehicles, DSRC network lacks the capacity to handle or properly allow sufficient data transmission. Therefore, the section 4.4.2.2.2 evaluates the DSRC network and establishes an equation of BSM messages over the networks.

*4.4.3.2.7 Metrics for evaluating DSRC message density.* Message density,  $k$ , can be defined as the number of messages in a particular time interval. Knowing the number of vehicles entering a roadway segment allows prediction of the number of BSMs that will be transmitted according to the DSRC standard. Therefore, to formulate a comprehensive equation for network congestion, all messages from all vehicles must be included. Messages sent by the  $i$ th vehicle are denoted as:

$\Omega_i = \{\Omega_1, \Omega_2, \Omega_3, \Omega_4 \dots \Omega_n\}$ . Unreliable connections may result in dropped messages and can be due to many reasons including out of range, environmental effects, or channel saturation. Thus excessive dropped messages can negatively impact network performance. The number of instantaneous dropped vehicle messages,  $\mu_i$ , can be represented as  $\mu_i = \{\mu_1, \mu_2, \mu_3, \dots \mu_n\}$ . The effects of  $\Omega_i$  and  $\mu_i$  on message density,  $k$ , is shown in (21).

$$k = \sum_{i=1}^n \left( \frac{\Omega_i - \mu_i}{d} \right) \quad \text{(Messages/Mile)} \quad (21)$$

**4.4.4 Possible solution to network congestion.** There need to be some methods that can help reduce network congestion for cases when  $K_{jam}$  is greater than  $C_{Vehmax}$ ; i.e., when the required BSM traffic exceeds the capacity of the communication channel. Reduction of this congestion could be accomplished a number of ways; however, whatever strategy is employed must not compromise the resulting safety of the vehicles. For example, network congestion could be reduced by minimizing the message packet size, since BSM part I messages contain static data fields, such as vehicle type, motion, and location, that do not change from message to message. BSM part II consists of large number of optional elements such as vehicle path history, hard braking, and emergency response. Eliminating redundant data would thereby shorten BSM packets and free up the channel to accommodate additional message traffic. Alternatively, the message rate could be reduced. However, the fundamental BSM message rate defined by J2735 is 10 messages per second, the most viable option is reduction in message size by a factor,  $\eta$ . Equation (22) describes how  $\eta$  is computed.

$$\eta = \frac{C_{Msgmax} \frac{Messages}{s}}{K_{jam} \text{ vehicle} * BSM \frac{Messages}{s * vehicle}} \quad (22)$$

When  $\eta \geq 1$ , the channel is not congested and no intervention is required. However, for  $\eta < 1$ , either message size or message rate must be modified. For example, using  $C_{Msgmax} = 1870 \text{ Msg/s}$  for a 6 Mbps communication channel and with a new  $K_{jam}$  of 250 vehicles, evaluation of (22) yields  $\eta = 0.75$ . The preferred message reduction strategy will be to trim the message size by  $\eta$  as shown in (23).

$$Message_{Size} = \eta * 400 \text{ bytes} \quad (23)$$

For the example with  $\eta = 0.75$ , the pruned message length would be 300 bytes in order to accommodate the increased number of vehicles while still maintaining 10 BSM/s.

Availability of an LTE channel could provide alternative means to broadcast command messages to all vehicles as shown in figure 4-6. The command would request all vehicles to shorten the BSM messages by  $\eta$ .

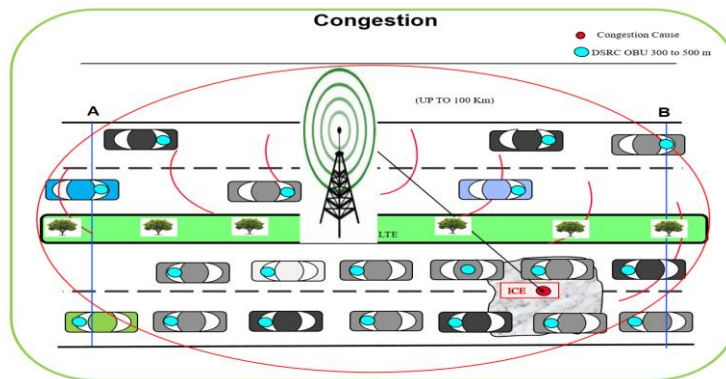

Figure 0.2: The use of LTE communication as a control channel

## Chapter 5

### Results and Discussion

This chapter summarizes the results of this work. The energy consumption algorithm results are summarized in section 5.1. Sections 5.2 and 5.3 describe the network congestion and traffic congestion results.

#### 5.1 Instantaneous Energy Consumption

The mathematical model described in chapter 4 was used to determine the level of remaining energy. For example, a vehicle with an estimated remaining energy of 10% needs an assessment to determine if sufficient energy remains to complete a transmission to surroundings vehicles. Figure 5-1 summarizes energy consumption for the model system investigated. The power data for the figure were obtained through measurement small using the INA219 current module. Sampling is performed at 30-second intervals over a period of 2 hours and forty minutes. Near the end of the experiment, the remaining energy approaches a constant value, indicating that power consumption has fallen to zero. This is because the battery voltage has fallen below the minimum level required by the attached electronic circuits.



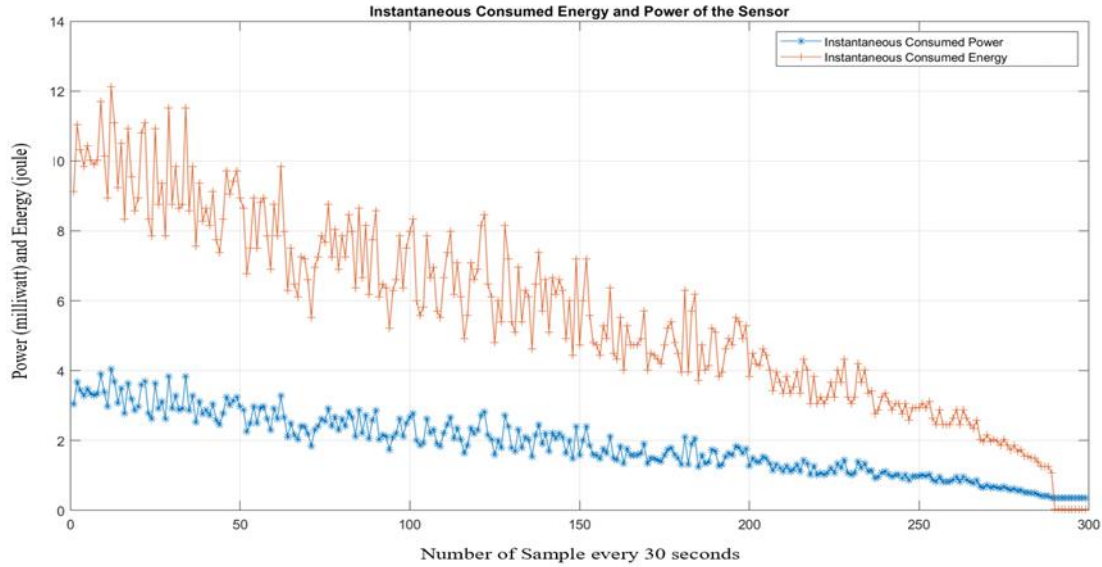

Figure 5.1: Instantaneous (every 30s) energy consumption plotted against sensor power consumption

Knowing the instantaneous power consumption, it is possible to calculate the consumed energy, which is then subtracted from the total energy of the power source to find the remaining energy reserves as shown in Figure 5.2.

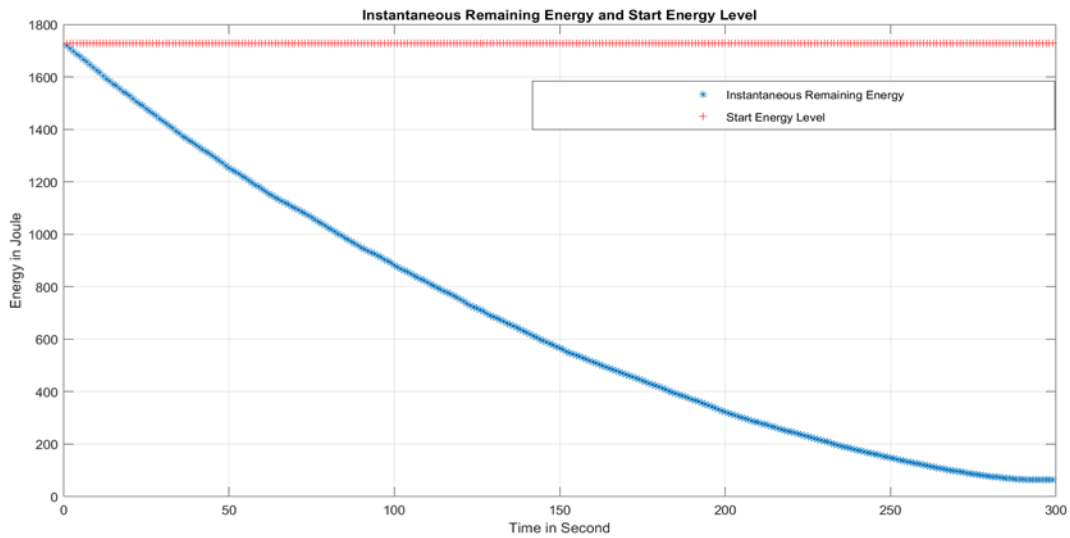

Figure 5.2: Starting energy and instantaneous remaining energy

The experiment shows that there is only a finite amount of energy available to perform a required set of vehicle sensing and communication tasks. The importance of the experiment is that it underscores the critical nature of energy availability. However, the experiment was a worst case scenario in that any practical system would be unlikely to rely on primary (non-rechargeable) battery technology, whereas a practical system would have a secondary (rechargeable) battery, which would be continuously charged by the vehicle. In the latter case, the secondary battery serves as an energy reserve. Under operating conditions when the onboard DSRC is powered by the backup battery, the same primary battery energy considerations apply to the secondary battery.

The DSRC system must continuously monitor energy consumption and energy availability in order to avoid entering a blackout condition where no BSM could be transmitted. In complex, multi-lane traffic scenarios, optimal routing of messages from one vehicle to a specific destination can rely Dijkstra's algorithm as described in section 4.4.2.

Figure 5.3 shows an example of a vehicle-to-vehicle routing path between an origin vehicle (v24) to a destination vehicle (v66) using the intervening vehicles v29—v59 as relay nodes.

```
temp6.getshortestPath('v24', 'v66');  
▶ (14) ["v24", "v29", "v31", "v33", "v34", "v41", "v48", "v49", "v50", "v52", "v53", "v54", "v59", "v66"]
```

Figure 5.3. Connecting vehicles from origin V24 to destination V66

Finding an optimal route from one vehicle to any other can be based on several metrics including minimum power, the maximum received signal strength indicator (RSSI), signal to noise ratio (SNR), minimum bit error rate (BER), and others. But the simplest of these is RSSI because each transceiver includes RSSI measurement capability. There is a strong interrelationship between these variables, but a high RSSI value implies a high SNR and a low BER. In this thesis, the function `getshortestPath()` is used to discover the edges between vehicles with minimum distance and cost, which simplistically means finding the highest values of RSSI between vehicles.

Figure 5.4 shows the set of vehicles and their costs. In this case, the cost function is analogous to the reciprocal of RSSI—i.e., a high RSSI corresponds to a low link budget.

```
JSON.stringify(temp6.getGraph().v24)
{"v25":0.025,"v26":0.05,"v27":0.077,"v28":0.1,"v29":0.125,"v30":0.15,"v31":0.175,"v32":0.202,"v33":0.225,"v34":0.25,"v35":0.275,"v36":0.3,"v37":0.325,"v38":0.35,"v39":0.375,"v40":0.4,"v41":0.425,"v42":0.45,"v43":0.475,"v44":0.5}
```

Figure 5.4. List of vehicles that v24 can connect to with different costs

## 5.2 DSRC Network Congestion Analysis

DSRC network congestion for a 6 Mbps channel begins when the vehicle density  $K$  reaches 187 vehicles as demonstrated in section 4.4.3. According to DSRC standard, BSM full messages are sent from a vehicle to its surroundings 10 times per second

whether there is no constraints. The network congestion will occur when there are more than 1870 BSM/s flowing through the communication channel. Due to the lack of sufficient channel, data exchanging between vehicles are not coherent; therefore, the safety application is reduced. Also, the safety application of DSRC technology can be reduced due to some natural phenomenons, which can cause message drop and result in bit errors and low signal to noise ratio effects such as noise, temperature, rain, or large communication range. The following figure describes DSRC network congestion when the density K goes beyond the threshold value.

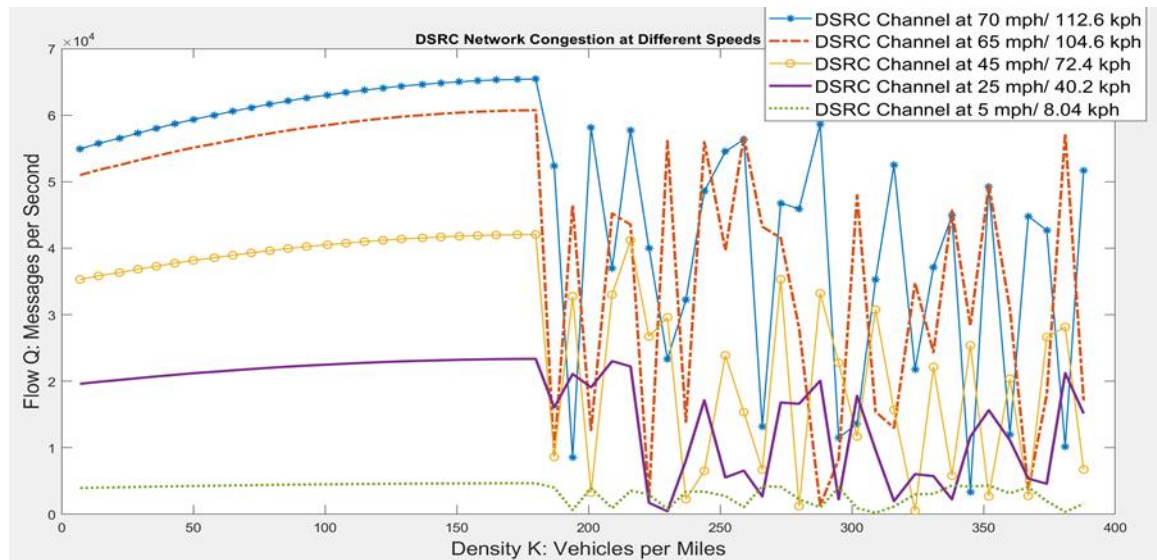

Figure 5.5. Channel Congestion when Density is more than 187 vehicles (45 mph)

Using LTE technology, all vehicles are informed of roadway status (congestion, temperature, accidents, icing, etc.). Due to the fact that a coming vehicle is re-routed, the traffic density of roadway segment is going to decrease instantaneously, therefore there will be a sufficient flow of BSM messages.).

### **5.3 DSRC Network Congestion Control**

The network congestion algorithm approaches reduction channel congestion by combining DSRC and LTE technologies. The network congestion for a 6 Mbps channel begins when vehicle density approaches 187 as described in section 4.4.2. At the point when network congestion begins to occur, the use of LTE is necessary to help solving the DSRC network congestion problem by transmitting control messages, which effectively shorten the BSM messages. This act is to repair the network congestion and restore the BSM rate to 10 messages/s.

To test the performance of the network congestion algorithm, five different speeds were used for the evaluation of the performance of a DSRC channel at a rate of 6 Mbps. Speeds ranged from a low of 5 mph to a high of 70 mph. Figure 5-6 shows the BSM messages for a congested DSRC network and the improvements realized using the algorithm proposed in this thesis.

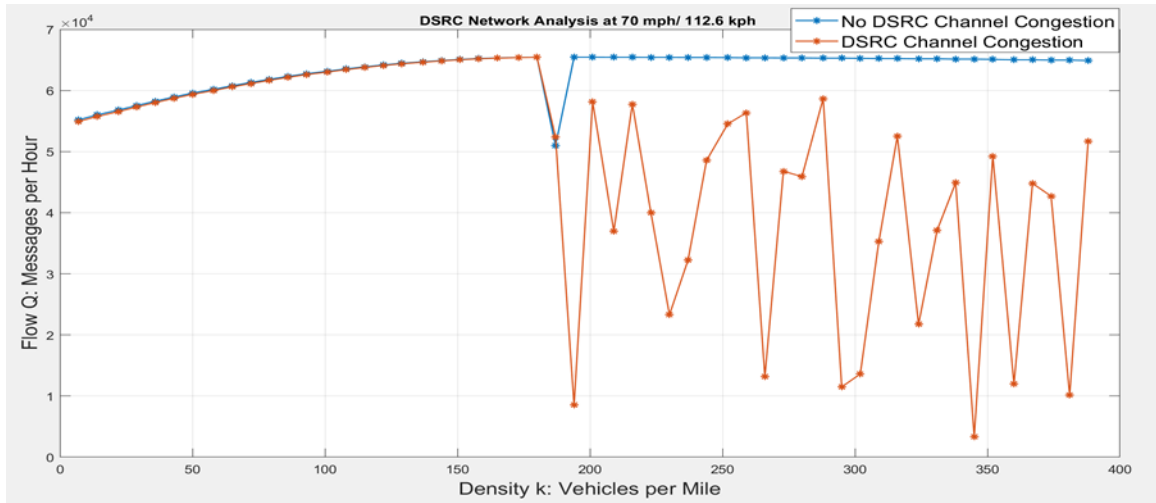

Figure 5.6. DSRC Channel with and without Congestion at Speed 70 mph

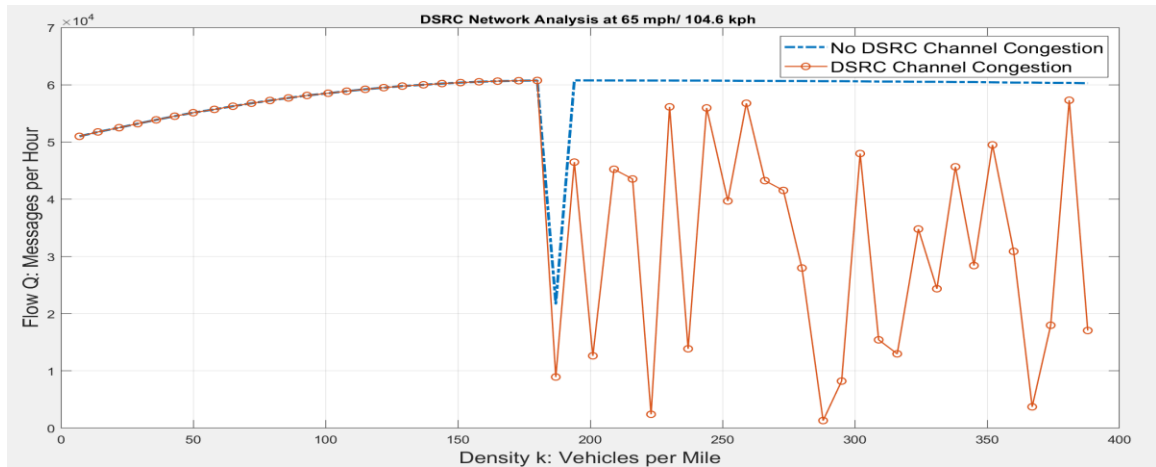

Figure 0.3. DSRC Channel with and without Congestion at Speed 65 mph

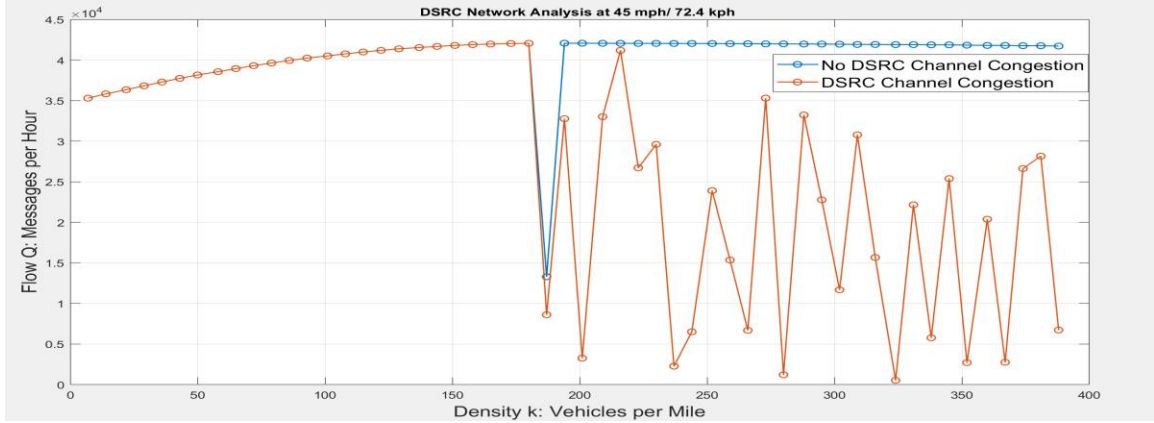

Figure 0.4. DSRC Channel with and without Congestion at Speed 45 mph

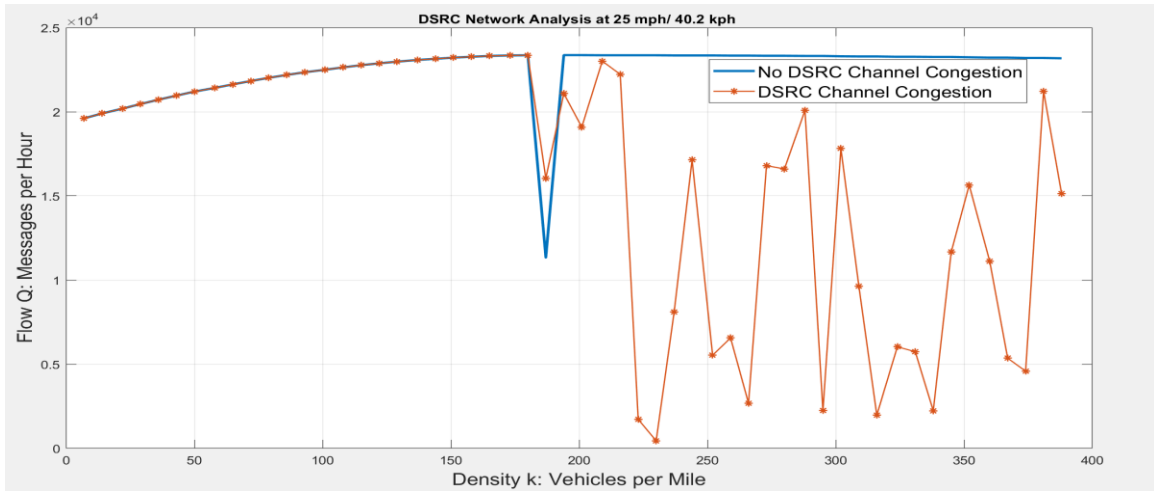

Figure 0.5. DSRC Channel with and without Congestion at Speed 25 mph

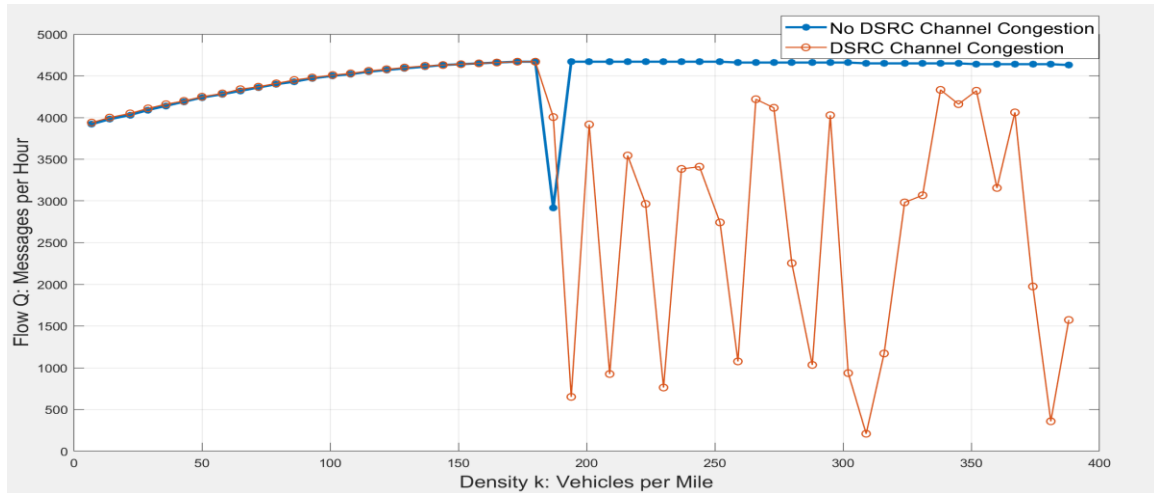

Figure 0.6. DSRC Channel with and without Congestion at Speed 5 mph

The lack of sufficient communication channel caused the random exchanging data of vehicles. Figure 5.10 shows that with a low speed, the BSM messages sent by individual vehicle are reduced due to the lack of communication channel. Some messages are received successfully; however, others are dropped. Use of LTE technology to truncate the BSM packet size (see Equations 22 and 23) frees up bandwidth to accommodate additional network traffic. Control messages are broadcast from the Department of Transportation (DOT) and are sent wirelessly from LTE antennas to all vehicles in the roadway segment.

#### 5.4 DSRC Channel Performance with Different Traffic Scenarios

To evaluate the performance of the DSRC channel, the study used five different speeds of the incoming vehicles into the roadway segment. The message size is 400 bytes which is sent from a vehicle to the neighbors 10 times every second based on DSRC standard. All vehicles are coming using a Poisson distribution. The speed is determined using a Normal distribution and the probability of nth vehicle into the roadway segment.



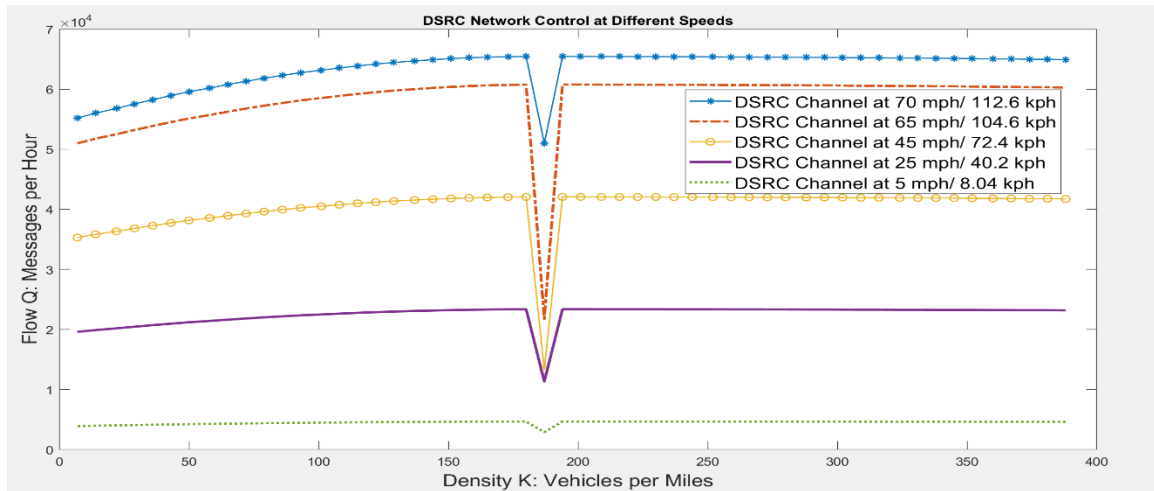

Figure 5.11. Basic Safety Messages of Vehicles at Different Speeds

The figure 5.11 shows the results of five different speed values. It shows that with a low speed, the roadway segment is close to congestion, and determines the result of the DSRC networks using the network congestion algorithm. The network congestion algorithm used in this work allows the BSMs to be sent successfully at different flow.

## Chapter 6

### Conclusions and Recommendations

This thesis investigates two main issues important to MANETs in the transportation field, specifically congestion control and energy consumption.

#### 6.1 Remarks

The increase of vehicles on roadways is a continuing challenge facing the transportation field. This research proposed two algorithms to address issues of energy consumption and network congestion.

The contribution this research has made shows that network congestion can be minimized by combining DSRC and LTE technologies. A potential disadvantage of LTE may be an increase in message latency and corresponding impacts on energy consumption. With continual rapid growth of connected vehicle technology, there will be more and more DSRC-equipped vehicles on roadways, which promises to provide for widespread adoption of the congestion and energy solutions developed in the thesis.

#### 6.2 Future Work

The investigation of data exchange in DSRC communication must go deeply for safety concerns. The combination of DSRC and LTE communication provides a huge contribution to solve congestion in the vehicular network. DSRC technology performs with low latency between vehicles and the efficient communication channel before congestion happened. The challenge is that DSRC cannot successfully send the required BSM messages due to its limited communication channel. If the number of vehicles is

increasing, obviously; the number of BSMs would be multiplied. Therefore, one method is to integrate the LTE technology in mobile ad hoc network because of its huge frequency band, which is over 300 Mbps. When congestion happens, the vehicle's network needs an external infrastructure to communicate in order to be informed. The drawback of the LTE communication is its high latency compared to the DSRC communication, and secured communication between vehicles and infrastructures. Another method to solve the network congestion is to minimize the message packet size, since BSM part I messages contain static data field. This would not affect DSRC safety application because vehicles will continuously send 10 messages per second. Using linear programming to minimize the message size with high density could be good research path in order to free up the communication channel. The protocols used in this research solve the road and networks congestion and ensure that the DSRC systems are not going to the congested state. When the channel is almost saturated, the approach using in Equation 23 will affect the message size broadcast by every vehicle. Moreover, as things become more connected, cyber security becomes one of the top problems.

## References

- [1] <https://www.who.int/news-room/fact-sheets/detail/road-traffic-injuries>. Seen 10/02/2019.
- [2] [http://www.who.int/violence\\_injury\\_prevention/road\\_safety\\_status/2015/en/](http://www.who.int/violence_injury_prevention/road_safety_status/2015/en/). "Global status report on road safety 2015." Seen 10/02/2019.
- [3] (2015 - 2019). ITS Photos Courtesy of USDOT 2015–2019 Strategic plan intelligent transportation systems (ITS).
- [4] W. M. Kang, J. D. Lee, Y.-S. Jeong, and J. H. Park, "Vcc-ssf: service-oriented security framework for vehicular cloud computing," *Sustainability*, vol. 7, no. 2, pp. 2028-2044, 2015.
- [5] F. Figueroa, J. Schmalzel, J. Morris, W. Solano, S. Mandayam, and R. Polikar, "A framework for intelligent rocket test facilities with smart sensor elements," in *Sensors for Industry Conference, 2004. Proceedings the ISA/IEEE, 2004: IEEE*, pp. 91-95.
- [6] (January 2018). Exploratory Advanced Research Program FHWA White Paper On Mobile Ad Hoc Networks. [Online] Available: <https://www.fhwa.dot.gov/publications/research/ear/18027/index.cfm>
- [7] G. Piro, L. A. Grieco, G. Boggia, F. Capozzi, and P. Camarda, "Simulating LTE cellular systems: An open-source framework," *IEEE transactions on vehicular technology*, vol. 60, no. 2, pp. 498-513, 2011.
- [8] F. T. AL-Dhief, N. Sabri, M. Salim, S. Fouad, and S. Aljunid, "MANET Routing Protocols Evaluation: AODV, DSR and DSDV Perspective," in *MATEC Web of Conferences, 2018, vol. 150: EDP Sciences*, p. 06024.
- [9] P. Jacquet, P. Muhlethaler, T. Clausen, A. Laouiti, A. Qayyum, and L. Viennot, "Optimized link state routing protocol for ad hoc networks," in *Multi Topic Conference, 2001. IEEE INMIC 2001. Technology for the 21st Century. Proceedings. IEEE International, 2001: IEEE*, pp. 62-68.
- [10] A. A. Anchari, A. Amin, and S. Ashraf, "Routing Problems in Mobile Ad hoc Networks (MANET)," 2017.
- [11] B. Chahidi and A. Ezzati, "Hybrid routing protocol for wireless sensor networks," *International Journal of Computer Science Issues (IJCSI)*, vol. 9, no. 2, p. 490, 2012.
- [12] G. Chandrasekaran, "Vanets: The networking platform for future vehicular applications," *Department of Computer Science, Rutgers University*, pp. 45-51, 2008.
- [13] K. Tanuja, T. Sushma, M. Bharathi, and K. Arun, "A survey on VANET technologies," *International journal of computer applications*, vol. 121, no. 18, 2015.
- [14] J. Guo and N. Balon, "Vehicular ad hoc networks and dedicated short-range communication," *University of Michigan*, 2006.
- [15] (June 8, 2016). Defining Auto Safety of Life in 5.9 GHz. [Online] Available: <https://www.fcc.gov/news-events/blog/2016/06/08/defining-auto-safety-life-59-ghz>

- [16] Y. Liu, F. Dion, and S. Biswas, "Dedicated short-range wireless communications for intelligent transportation system applications: State of the art," *Transportation Research Record: Journal of the Transportation Research Board*, no. 1910, pp. 29-37, 2005.
- [17] Global harmonization of connected vehicle communication standards, January 12, 2016. [Online]. Available: <http://www.cargroup.org/wp-content/uploads/2017/02/Global-harmonization-of-connected-vehicle-communication-standards.pdf>
- [18] Dedicated Short-Range Communications (DSRC) Fact Sheet – U.S. Department of Transportation ITS JPO [Online] Available: [https://www.its.dot.gov/factsheets/pdf/JPO-034\\_DSRC.pdf](https://www.its.dot.gov/factsheets/pdf/JPO-034_DSRC.pdf)
- [19] (2009). IEEE 1609 - Family of Standards for Wireless Access in Vehicular Environments (WAVE). [Online] Available: <https://www.standards.its.dot.gov/Factsheets/Factsheet/80>
- [20] L. E. F. Austin, *Principles of Electronic Communication Systems* < p class="BodyThesis". Texas, 1998.
- [21] B. Wu, A. N. Tait, M. P. Chang, and P. R. Prucnal, "WDM optical steganography based on amplified spontaneous emission noise," *Optics letters*, vol. 39, no. 20, pp. 5925-5928, 2014.
- [22] T. Zhang and L. Delgrossi, *Vehicle safety communications: protocols, security, and privacy*. John Wiley & Sons, 2012.
- [23] S. B. Raut, P. R. Bajaj, and L. G. Malik, "Prediction of vehicle collision probability at intersection using V2V communication," *Int. J. Sci. Eng. Res*, vol. 6, pp. 295-300, 2015.
- [24] C. N. L. C. W. Hsu, L. Y. Ke, H. Y. Huang, F. Y. Huang Automotive Research & Testing Center No.6, Lugong S. 7th Rd., Lugang Town, Changhua Country winsonhsu@artc.org.tw, "A Collision Avoidance Achievement of Vehicle Warning System in Intersection via DSRC." [Online]. Available: <https://testing.bsmi.gov.tw/wSite/public/Attachment/f1290744322477.pdf>.
- [25] (September 25, 2009). SAE J2735 - Dedicated Short Range Communications (DSRC) Message Set Dictionary. [Online] Available: <https://standards.its.dot.gov/Factsheets/Factsheet/71>
- [26] SAE, "DSRC Implementation guide-A guide to users of SAE J2735 message sets over DSRC," ed, 2010.
- [27] S. R. Institute, T.-. San Antonio, "Interface control document for the NYS CVII DSRC Message Set," ed, December 9, 2011.
- [28] A. Group, "Signal Phase and Time (SPAT) and Map Data (MAP)," ed, 01 / 09 / 2015.
- [29] C. Campolo, A. Vinel, A. Molinaro, and Y. Koucheryavy, "Modeling broadcasting in IEEE 802.11 p/WAVE vehicular networks," *IEEE Communications letters*, vol. 15, no. 2, pp. 199-201, 2011.
- [30] J. Postel, "User datagram protocol," 2070-1721, 1980.
- [31] Y. Tian, Y. Wang, R. Song, and H. Song, "Accurate vehicle detection and counting algorithm for traffic data collection," in *2015 International Conference on Connected Vehicles and Expo (ICCVE)*, 2015: IEEE, pp. 285-290.

- [32] M. N. Halgamuge, M. Zukerman, K. Ramamohanarao, and H. L. Vu, "An estimation of sensor energy consumption," *Progress in Electromagnetics Research*, vol. 12, pp. 259-295, 2009.
- [33] M. A. Razzaque and S. Dobson, "Energy-efficient sensing in wireless sensor networks using compressed sensing," *Sensors*, vol. 14, no. 2, pp. 2822-2859, 2014.
- [34] F. Kaup, P. Gottschling, and D. Hausheer, "PowerPi: Measuring and modeling the power consumption of the Raspberry Pi," in *Local Computer Networks (LCN), 2014 IEEE 39th Conference on*, 2014: IEEE, pp. 236-243.
- [35] Y. Park and H. Kim, "Application-level frequency control of periodic safety messages in the IEEE WAVE," *IEEE Transactions on Vehicular Technology*, vol. 61, no. 4, pp. 1854-1862, 2012.
- [36] A. Rostami, H. Krishnan, and M. Gruteser, "V2V Safety Communication Scalability Based on the SAE J2945/1 Standard."
- [37] C.-J. Hsu, J. Fikentscher, and R. Kreeb, "Development of potential methods for testing congestion control algorithm implemented in vehicle-to-vehicle communications," *Traffic injury prevention*, vol. 18, no. sup1, pp. S51-S57, 2017.
- [38] J. B. Kenney, G. Bansal, and C. E. Rohrs, "Limeric: a linear message rate control algorithm for vehicular DSRC systems," in *Proceedings of the Eighth ACM international workshop on Vehicular inter-networking*, 2011: ACM, pp. 21-30.
- [39] S. Subramanian, M. Werner, S. Liu, J. Jose, R. Lupoiaie, and X. Wu, "Congestion control for vehicular safety: synchronous and asynchronous MAC algorithms," in *Proceedings of the ninth ACM international workshop on Vehicular inter-networking, systems, and applications*, 2012: ACM, pp. 63-72.
- [40] T. Osafune, Y. Horita, N. Mariyasagayam, and M. Lenardi, "Effect of decentralized congestion control on cooperative systems," *International Journal of Intelligent Transportation Systems Research*, vol. 13, no. 3, pp. 192-202, 2015.
- [41] S. Afzal and M. Kabeer, "Long Term Evolution (LTE) communication system : functional blocks and working."
- [42] M. Zulhasnine, C. Huang, and A. Srinivasan, "Efficient resource allocation for device-to-device communication underlying LTE network," in *Wireless and Mobile Computing, Networking and Communications (WiMob), 2010 IEEE 6th International Conference on*, 2010: IEEE, pp. 368-375.
- [43] Z. Xu, X. Li, X. Zhao, M. H. Zhang, and Z. Wang, "DSRC versus 4G-LTE for connected vehicle applications: a study on field experiments of vehicular communication performance," *Journal of Advanced Transportation*, vol. 2017, 2017.
- [44] O. Khaing, M. Thanlyin, H. H. Wai, and E. E. Myat, "Using Dijkstra's Algorithm for Public Transportation System in Yangon Based on GIS."
- [45] Y. Deng, Y. Chen, Y. Zhang, and S. Mahadevan, "Fuzzy Dijkstra algorithm for shortest path problem under uncertain environment," *Applied Soft Computing*, vol. 12, no. 3, pp. 1231-1237, 2012.
- [46] P. Bhavsar, "Development of an environmental and operational impact assessment framework for connected vehicle technology supported alternative fuel vehicles," the Graduate School of Clemson University, Clemson University, parthb@clemson.edu, 8-2013.

- [47] k.konte. "<https://github.com/Babakonte/Dedicated-Short-Range-Communication/edit/master/readme.md>."
- [48] C. S. Sathya Bandari, Hussein Syed Mohammed, and John Schmalzel, "Component Electronic Datasheets in ISHM Department of Electrical and Computer Engineering, Rowan University " 7-9 February 2006.
- [49] N. Voudoukis, "Performance Analysis, Characteristics, and Simulation of Digital QAM," European Journal of Electrical Engineering and Computer Science, vol. 1, no. 1, 2017.
- [50] Ström, E. G. (2013, November). On 20 MHz channel spacing for V2X communication based on 802.11 OFDM. In IECON 2013-39th Annual Conference of the IEEE Industrial Electronics Society (pp. 6891-6896). IEEE.
- [51] A. Bull, Ed. Traffic Congestion the problem and how to deal with it. 2003.